

**L'éclipse solaire du lundi 21 août 2017
par Julien Dompierre**

Une présentation de la
Société d'astronomie de Montréal.
Un organisme bénévole à but non lucratif.
<http://www.lasam.ca/>

La Société d'astronomie de Montréal

**Centre francophone de Montréal
de la Société royale d'astronomie du Canada**



Sommaire

- Les éclipses solaires
- L'éclipse totale solaire du 21 août 2017
- L'éclipse solaire partielle à Montréal
- Comment observer une éclipse solaire
- L'éclipse solaire totale aux États-Unis
- Observations à faire

Les éclipse solaires

Une **éclipse solaire** se produit lorsque la Lune se place devant le Soleil, occultant totalement ou partiellement l'image du Soleil depuis la Terre.

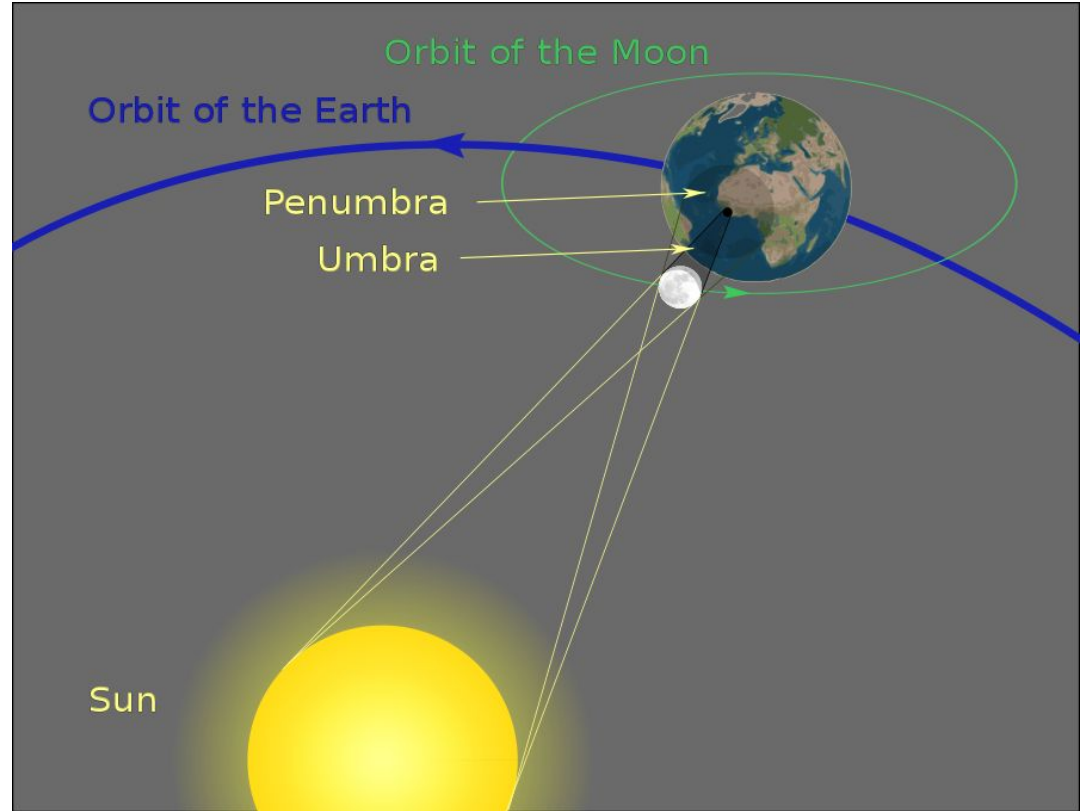

Les éclipses solaires 2001-2020

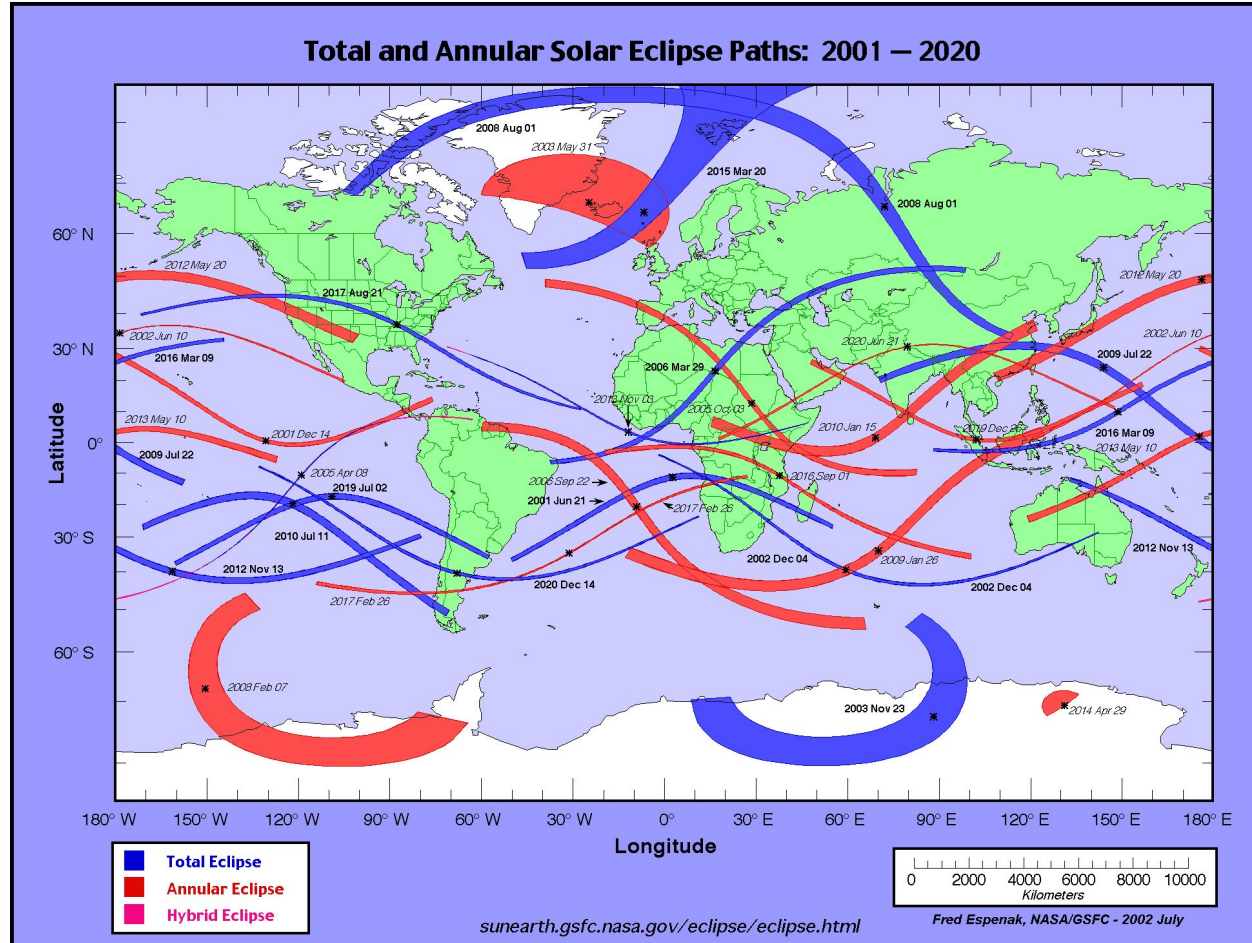

Les éclipse solaires en Amérique du Nord

Total Solar Eclipses: 1951 - 2000



Total Solar Eclipses: 2001 - 2050



Éclipse solaire du 21 août 2017

Total Solar Eclipse of 2017 August 21

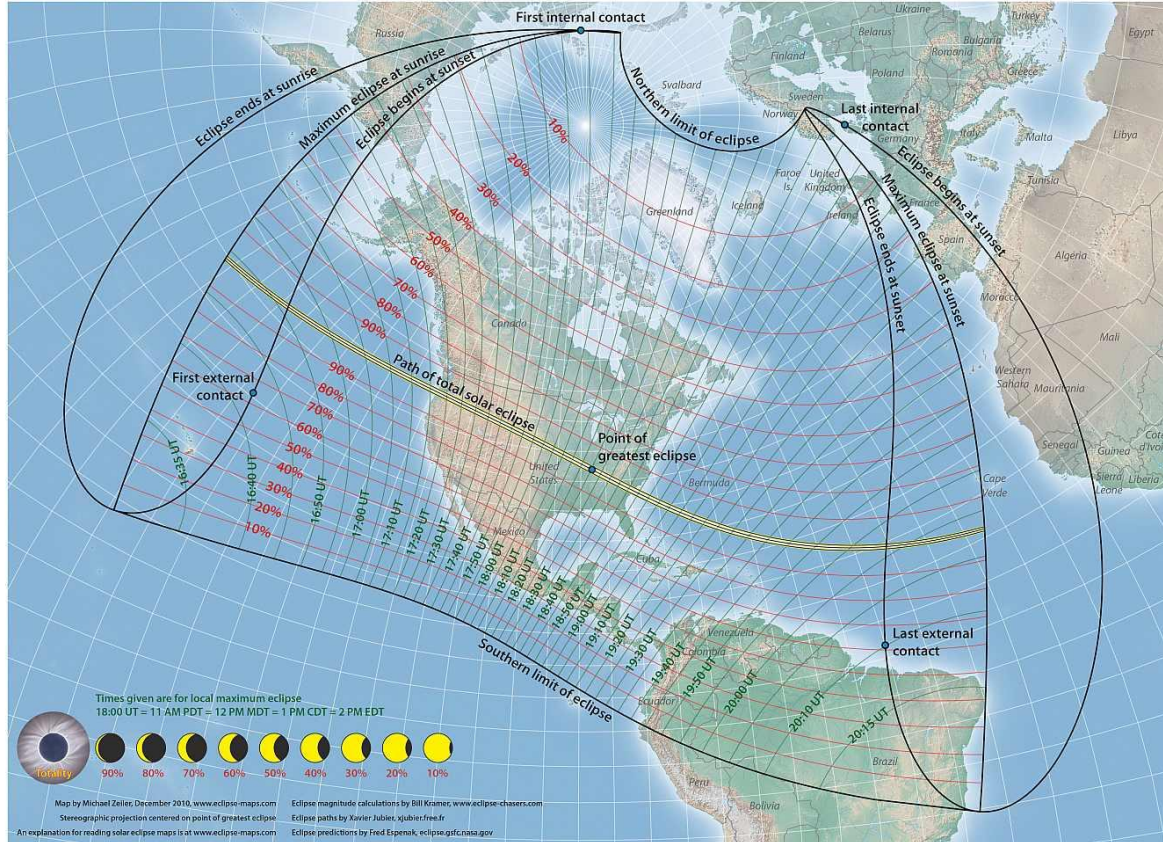

Éclipse solaire partielle à Montréal

Le 21 août 2017 (dans 66 jours....)

- Lever du Soleil à 06h02
- Début de l'éclipse à 13h21m55s
- Milieu de l'éclipse à 14h36m00s (65.9% du diamètre du Soleil est couvert par la Lune)
- Fin de l'éclipse à 15h50m05s
- Coucher du Soleil à 19h51

Éclipse solaire partielle à Montréal



Phases of Partial Eclipse at 70% Obscuration
As Seen through Eclipse Shades

Observer une éclipse solaire

Il existe plus d'une dizaine de façons différentes d'observer le Soleil **sécuritairement**.

Je les présente des plus **simples** et plus **abordables** aux plus **complexes** et **coûteuses**.

ATTENTION: DANGER

- Il ne faut jamais regarder directement le Soleil.
- L'observation du Soleil peut rendre aveugle en quelques secondes.
- Il faut surveiller les enfants.

Dans les médias et sur l'internet ...

... surtout s'il fait mauvais à Montréal !-(...

Radio Canada

CBC

CNN

Fox News

spaceweather.com

 **spaceweather.com**
News and information about the Sun-Earth environment

Subscribe to SpaceweatherNews

[AURORA ALERTS](#) | [SUBMIT YOUR PHOTOS](#) | [CONTACT US](#) | [SUBSCRIBE](#) | [FLYBYS](#) | [EARTH TO SKY](#)

Current Conditions

Solar wind
speed: **449.2** km/sec
density: **4.2** protons/cm³
more data: [ACE](#) [DSCOVER](#)
Updated: Today at 0344 UT

X-ray Solar Flares
6-hr max: **B2** 2106 UT Jun14
24-hr: **B2** 2106 UT Jun14
[explanation](#) | [more data](#)
Updated: Today at: 2359 UT

Daily Sun: 14 Jun 17

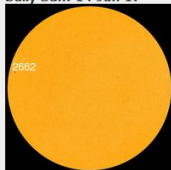

New sunspot AR2662 has broken a string of 4 spotless days. Credit: SDO/HMI

Sunspot number: 11
[What is the sunspot number?](#)
Updated 14 Jun 2017

Spotless Days
Current Stretch: 0 days
2017 total: 42 days (25%)
2016 total: 32 days (9%)
2015 total: 0 days (0%)
2014 total: 1 day (<1%)
2013 total: 0 days (0%)
2012 total: 0 days (0%)
2011 total: 2 days (<1%)
2010 total: 51 days (14%)
2009 total: 260 days (71%)
Updated 14 Jun 2017

The Radio Sun
10.7 cm flux: **75** sfu
[explanation](#) | [more data](#)
Updated 14 Jun 2017

What's up in space

Thursday, Jun. 15, 2017

Lights Over lapland is excited to announce that [Autumn Aurora Adventures](#) are available for immediate booking! Reserve your adventure of a lifetime in Abisko National Park, Sweden today!



NASA TRIES AGAIN TO PRODUCE ARTIFICIAL CLOUDS: On Thursday **June 15th**, NASA will attempt to overcome a series of weather and hazard-related postponements to launch a sounding rocket over the east coast of the USA. The Terrier-Improved Malemute rocket will blast off between **9:05 and 9:20 p.m. EDT** and release a network of red and blue-green vapors more than 100 miles high. Tracking the motions of the colorful gases will help researchers study the dynamics of Earth's [ionosphere](#). The vapor tracers may be visible from New York to North Carolina and westward to Charlottesville, Virginia.

A HOLE IN THE SUN'S ATMOSPHERE: A large hole has opened in the sun's atmosphere and it is turning toward Earth. NASA's Solar Dynamics Observatory is monitoring the structure, shown here in an extreme ultraviolet image taken on June 13th:

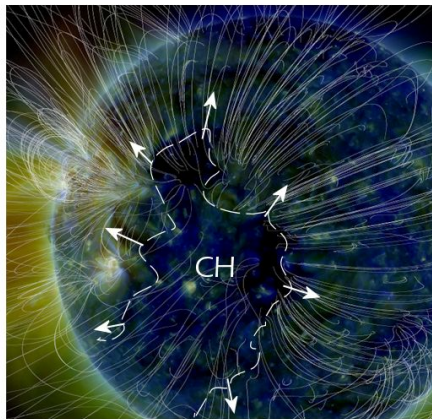

This is a coronal hole (CH) -- a region where the sun's magnetic field peels back and allows solar wind to escape. A fast-moving stream of solar wind from this coronal hole is expected to arrive on June 16th, possibly sparking [G1-class](#)

archives

June
15
2017



Captain Boom
FIREWORKS

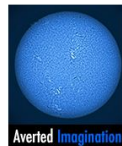

Page de démarrage de Mozil x Boîte de réception (9) - juli... x PresentationEclipseSolaire - x EclipseSolaireDu21Août2017 x H_A Total Eclipse, lundi 21 août x +

www.heavens-above.com/SolarEclipse.aspx?dmax=2457987.2685213

Les plus visités Débuter avec Firefox Montréal, QC - Prévisi...

Pseudo: anonymous Login
Localisation: Unspecified (0.0000°N, 0.0000°E)
Heure: 03:48:16 (UTC+00:00)
Langue: Français English



Total Eclipse, lundi 21 août 2017

Éclipses solaires **General Circumstances** Local Circumstances Interactive Map Animation

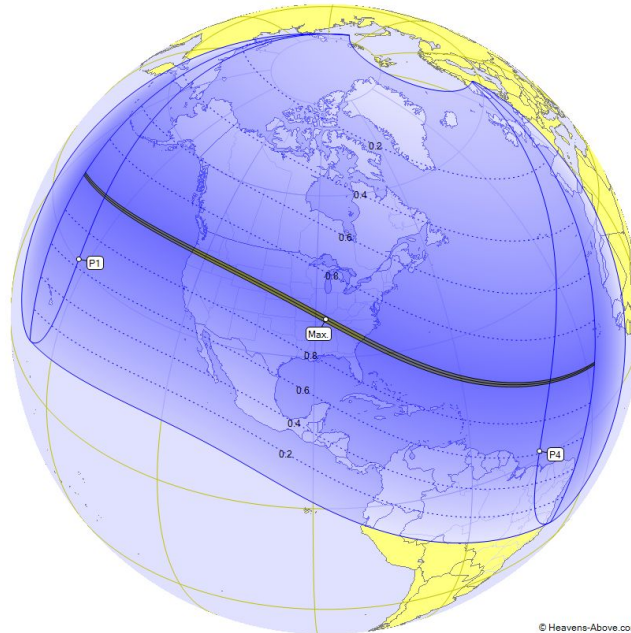

© Heavens-Above.com

eclipse.gsfc.nasa.gov/eclipse.html

 NATIONAL AERONAUTICS AND SPACE ADMINISTRATION
EXPLORE. DISCOVER. UNDERSTAND.

+ NASA Portal
+ Sun-Earth Day
+ Eclipse Bulletins
+ Eclipses During 2017

HOME | SOLAR ECLIPSES | LUNAR ECLIPSES | TRANSITS



NASA Eclipse Web Site

NASA GODDARD SPACE FLIGHT CENTER ECLIPSE WEB SITE

eclipse.gsfc.nasa.gov/eclipse.html

More on Eclipses at www.nasa.gov/eclipse

The next Total Solar Eclipse visible from the USA on 2017 Aug 21
[Main NASA site for this eclipse](#)

EXPERIENCE THE 2017 ECLIPSE ACROSS AMERICA

AUGUST 21, 2017 [FIND OUT MORE](#)

<http://eclipse2017.nasa.gov>

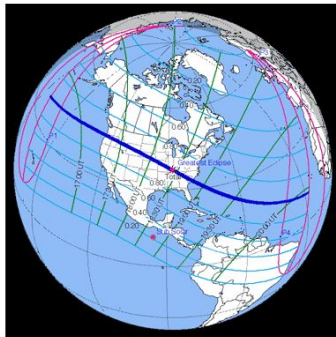



[More on the 2017 Aug 21 eclipse here](#)

Page de démarrage de Moz... Boîte de réception (9) - juil... PresentationEclipseSolaire - EclipseSolaireDu21Aout2017 - NASA Eclipse Web Site - Total Solar Eclipse 2017

<https://eclipse2017.nasa.gov>

Les plus visités: Débuter avec Firefox, Montréal, QC - Prévisi...

  ECLIPSE 101 | EVENTS | SCIENCE | ACTIVITIES | EDUCATION | RESOURCES

SAVE THE DATE

JUNE 21, 2017 1:00 - 3:30 PM ET
NASA "TWO MONTHS TO THE ECLIPSE" PRESS CONFERENCE

GET READY FOR THIS SUMMER'S
2017 ECLIPSE ACROSS AMERICA
THROUGH THE EYES OF NASA

Live from the Newseum in Washington, DC
See it on NASA TV and www.nasa.gov

Eclipse Countdown Until First Contact in Oregon August 21, 2017 UT

09:04:00:14
9 weeks, 4 days, 0 hours, and 14 minutes left



Total Solar Eclipse August 21, 2017

On Monday, August 21, 2017, all of North America will be treated to an eclipse of the sun. Anyone within the path of totality can see one of nature's most awe inspiring sights - a total solar eclipse. This path, where the moon will completely cover the sun and the sun's tenuous atmosphere - the corona - can be seen, will stretch from Salem, Oregon to Charleston, South Carolina. Observers outside this path will still see a partial solar eclipse where the moon covers part of the sun's disk. NASA created this website to provide a guide to this amazing event. Here you will find activities, events, broadcasts, and resources from NASA and our partners across the nation.

SCIENCE SAFETY PUBLIC ENGAGEMENT CITIZEN SCIENCE EDUCATION EVENTS

ECLIPSE SCIENCE



Avec des lunettes solaires



Avec des lunettes solaires

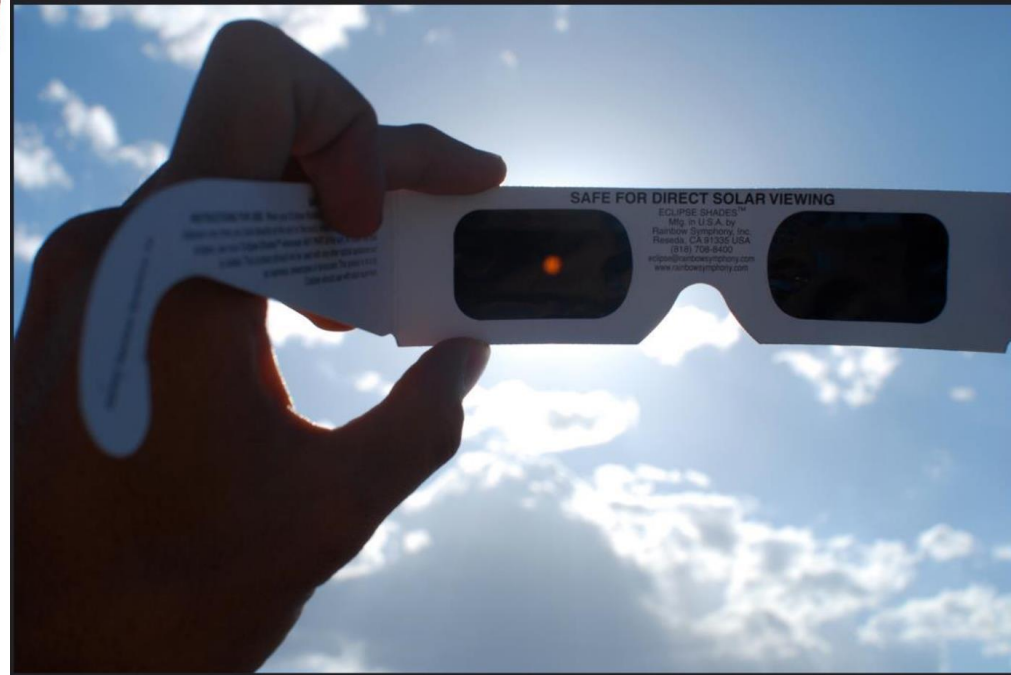

Avec des lunettes solaires Baader



Avec des lunettes solaires



Avec une boîte à chaussures !-)

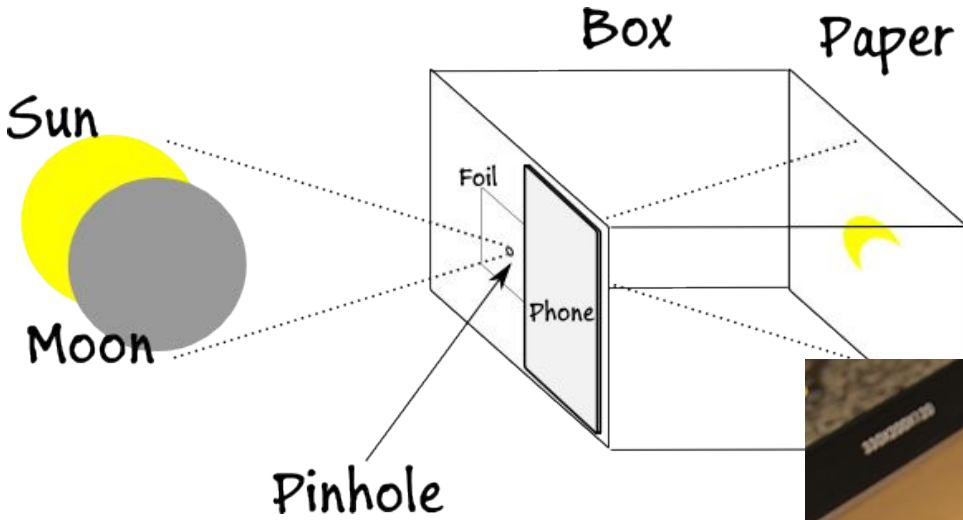

Projection par un trou d'aiguille

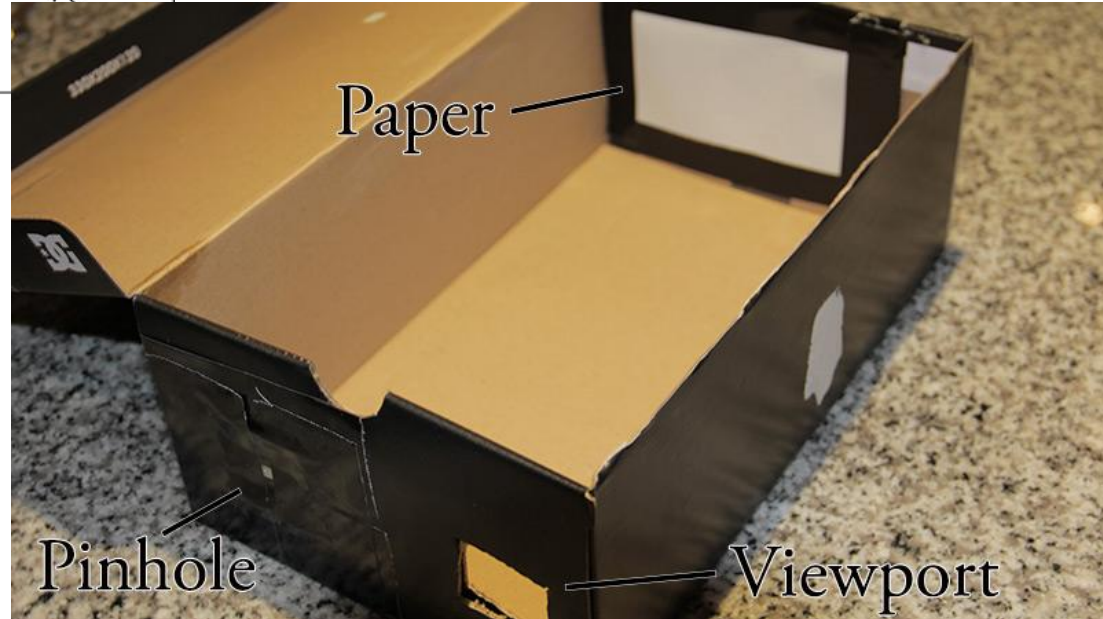

Avec une boîte à chaussures !-)



Avec une boîte à chaussures !-)



Avec une boîte à chaussures !-)



Avec une boîte à chaussures !-)

Pinhole projector using a box

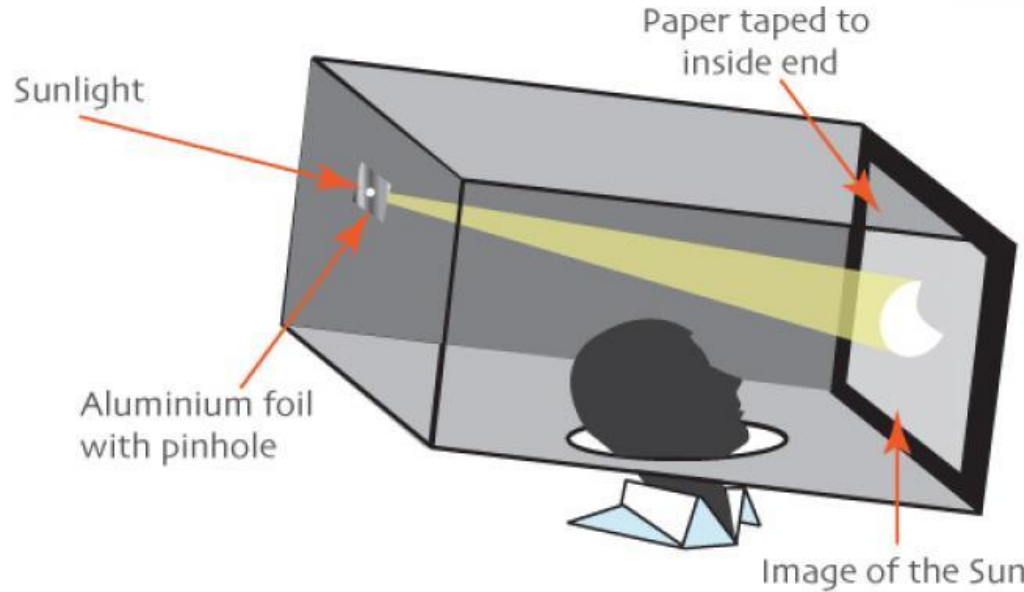

Projection avec un instrument optique

Concept: L'optique projette une image du Soleil sur un écran blanc.

- Jumelles
- Réfracteur (lunette achromatique)
- SunSpotter
- SolarScope
- Réflecteur (télescope de Newton)

Projection avec des jumelles



Projection avec des jumelles

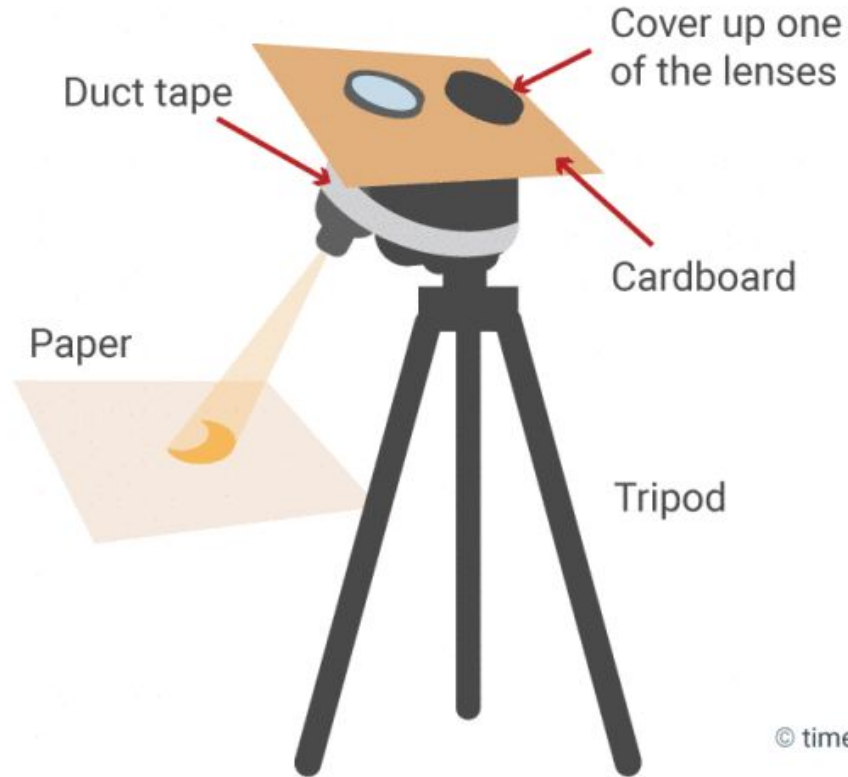

Projection avec des jumelles

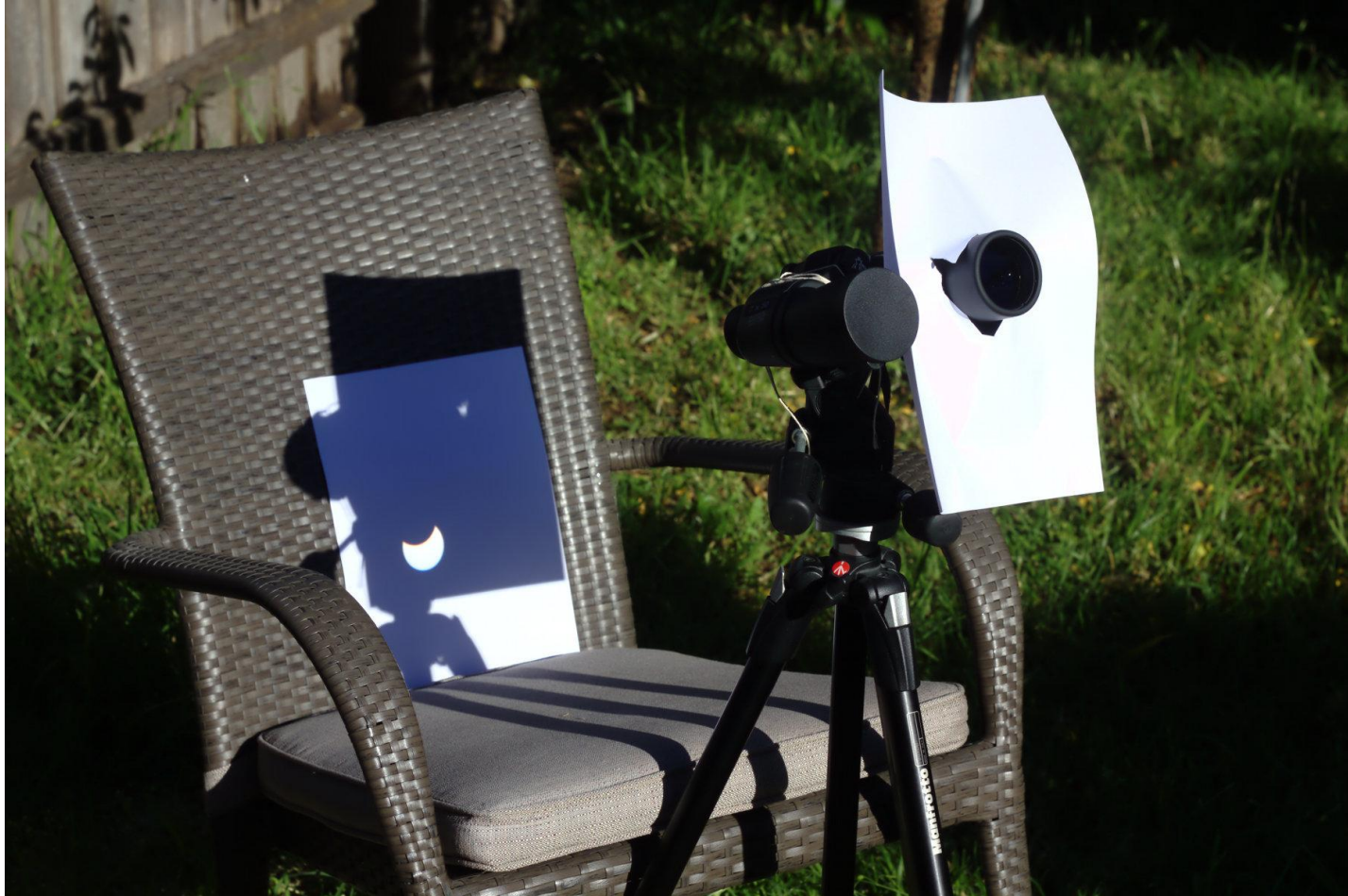

Projection avec un réfracteur

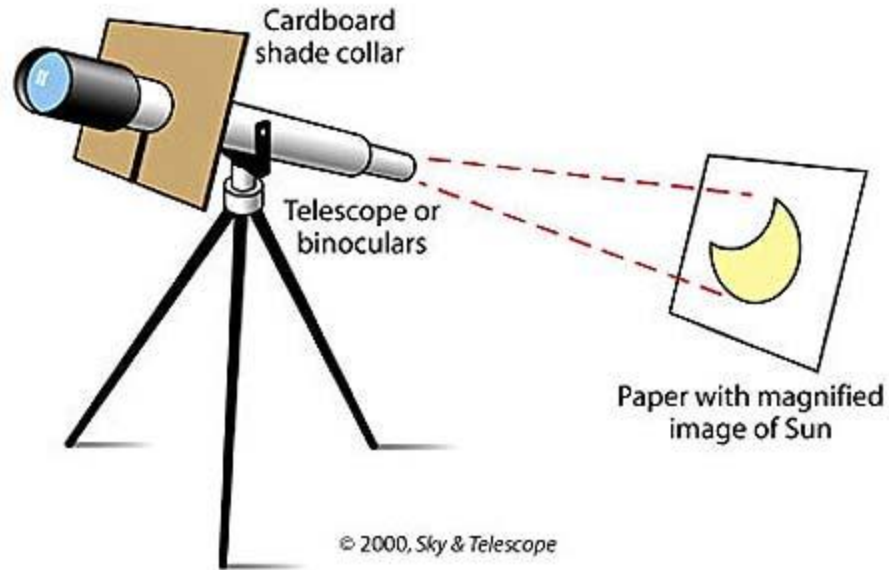

Projection avec un réfracteur



Projection avec un réfracteur



SunSpotter

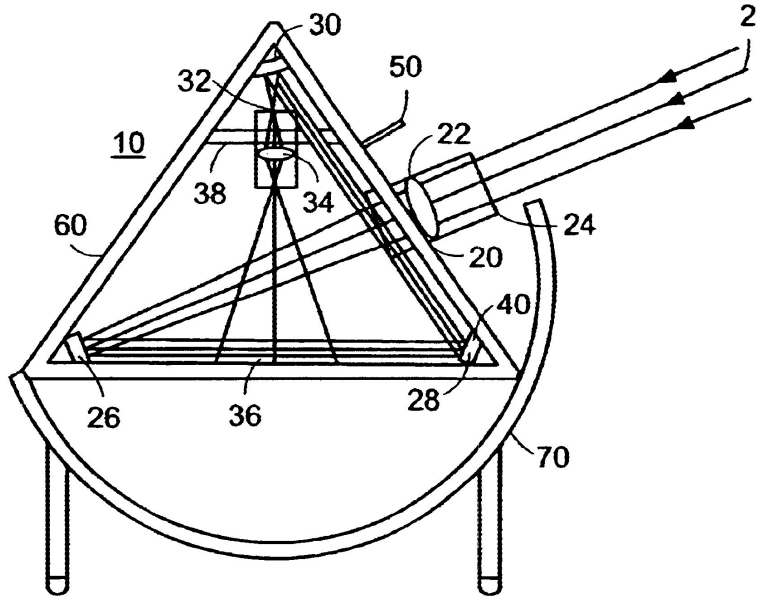

FIG. 1



SunSpotter



SolarScope

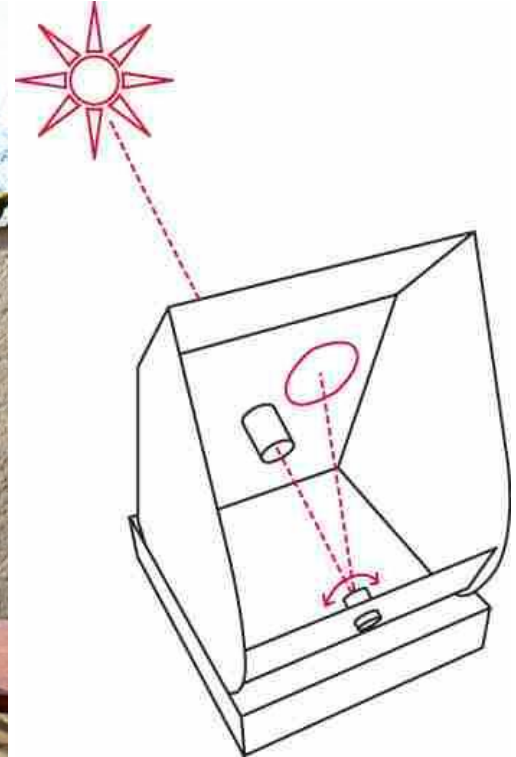

SolarScope



Projection avec un réflecteur



Projection avec un réflecteur



Projection dans un entonnoir



Projection dans un entonnoir



Observation solaire par projection

Sécuritaire pour les yeux...

... mais pas sécuritaire pour le télescope !-)



Filtres solaires

- Baader AstroSolar
- Thousand Oaks SolarLite
- Verre

Baader AstroSolar

**Original BAADER AstroSolar™
Sonnenfilter-Folie**

Folie zum Beobachten der Sonne mit
Feldstecher,
CC-e-qualitätsgeprüftes Spezialmaterial
zur Reduzierung der

**So bauen Sie sich
Folien**

1. Schneiden Sie nach Kartenausschnitt...
2. Kleben Sie beide Kartenausschnitte...
3. Kleben Sie die Folie...
4. Legen Sie ein...
5. Die Folie...
6. Die Folie...
7. Dann...
8. Die Folie...

Das ist es!

Die Sonnenfilter-Folie...

BAADER PLANETARIUM GmbH

**BAADER AstroSolar™
Sonnenfilter-Folie**

**Ideal geeignet zum Anfertigen von Objektivfiltern für
Feldstecher, Teleskop, Foto- und Videokameras.**

- Für unsere professionellen Sonnenfiltere beschreiben wir ein absolut neues und schwebendes Bag-in-Matrix-Prinzip.
- Die Entwicklung stammt aus Labors in Wien und ist das Ergebnis intensiver Arbeit. Absolute Sicherheit und maximale Qualität vor jeder planetarischen Beobachtung.
- Unsere Folie wird hergestellt mit ultradünnen Schichten aus Silikon- und Kohlenstoff auf einer stabilen Kunststoff-Folie. Das Ergebnis ist ein Filter, der keine Gefahr für Ihre Augen und Ihr Instrument darstellt und ein weiteres normales Sonnenfiltere bietet. Ein weiterer Vorteil der Materialkombination ist die gleichzeitige Filterfunktion.
- Die Beschichtung der BAADER AstroSolar™ Sonnenfiltere wird durch spezielle Qualitätskontrollen...

...enthalten. Die Filterung...

BAADER AstroSolar™ Sonnenfilter-Folie ist in folgenden Größen erhältlich:

- BAADER AstroSolar™ Sonnenfilter-Folie im Durchmesser 100 x 100 mm, 150 x 150 mm, 200 x 200 mm, 250 x 250 mm, 300 x 300 mm, 350 x 350 mm, 400 x 400 mm, 450 x 450 mm, 500 x 500 mm, 600 x 600 mm, 700 x 700 mm, 800 x 800 mm, 900 x 900 mm, 1000 x 1000 mm.
- BAADER AstroSolar™ Sonnenfilter-Folie im Durchmesser 100 x 100 mm, 150 x 150 mm, 200 x 200 mm, 250 x 250 mm, 300 x 300 mm, 350 x 350 mm, 400 x 400 mm, 450 x 450 mm, 500 x 500 mm, 600 x 600 mm, 700 x 700 mm, 800 x 800 mm, 900 x 900 mm, 1000 x 1000 mm.
- BAADER AstroSolar™ Sonnenfilter-Folie im Durchmesser 100 x 100 mm, 150 x 150 mm, 200 x 200 mm, 250 x 250 mm, 300 x 300 mm, 350 x 350 mm, 400 x 400 mm, 450 x 450 mm, 500 x 500 mm, 600 x 600 mm, 700 x 700 mm, 800 x 800 mm, 900 x 900 mm, 1000 x 1000 mm.

BAADER PLANETARIUM

45 Jahre

2018 Baaderstr. 1 • D-82061 München • Tel. +49 (0) 89 45 1800-1 • Fax +49 (0) 89 45 1800-100
www.baader-planetarium.de baader@baader-planetarium.de

Baader AstroSolar



Photographie : Patrick Thollot

Baader AstroSolar

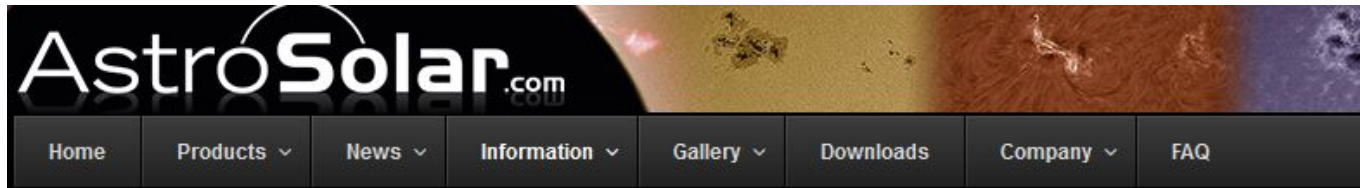

[Home](#) » [Information](#) » [How To – build your own solar filter](#) » How to make your own objective solar filter for your camera, telescope, spotting scope or binocular

How to make your own objective solar filter for your camera, telescope, spotting scope or binocular

What you need:

- Baader AstroSolar™ Safety Film
- two sheets of white stiff cardboard
- pair of scissors
- pair of dividers
- Some pieces of "Kleenex"- tissue
- double sticky tape
- Paper glue



RESULT:
Self-made
Solar Filter
attached onto
Celestron Astromaster
70mm Refractor

Baader AstroSolar

What you need for making your own solar filter: Baader AstroSolar® Safety Film, two sheets of white stiff cardboard, pair of scissors, pair of dividers, some pieces of "Kleenex"-tissue, double sticky tape, paper glue

1. Cut two equal sized rings out of stiff cardboard. The inner diameter should match the full aperture of the objective lens, the outer diameter should be 10cm (~4") larger.
2. Cover one full face of each cardboard-ring with double sticky tape. Cleanly cut away any inner and outer excess tape, so that only the two cardboard faces of both rings are covered with the sticky tape



3. Stretch out a square piece of "Kleenex" or similar facial tissue flat on a hard plane surface (a table) and secure the four corners of the tissue with clear adhesive tape. The tissue must be without any wrinkles.



4. Cut a square piece of AstroSolar®

Safety-Film a little larger than the outer diameter of the stiff cardboard rings.

When cutting AstroSolar® Safety-Film, always keep it protected between two sheets of white paper. This paper-film-paper "sandwich" is easily cut without creasing the film or getting fingerprints on it. The latest version of AstroSolar® Safety Film comes with a protective layer already on both sides.

5. Gently place the AstroSolar® Safety-Film onto the flat tissue and secure the four corners with tape – but do not stretch it! Remove the paper on top of the film. If your AstroSolar® film came with protective layers, gently peel away the one facing upwards at this time.

AstroSolar® Safety-Film must not be put under tension if it is to retain its precision optical property!

6. Hold one cardboard ring, with the sticky side down, 10 millimeters above the film and let it fall down onto the film, so that the ring touches the film all around at the same time.
7. Turn over the cardboard ring with the film covered side facing upward and lay it back onto the Kleenex. Remove the second paper or built-in protective layer, and then stick the second cardboard ring against it. You have created a round film-holder with AstroSolar® Safety-Film cleanly and securely fastened without creases and wrinkles – but, most of all: **without stressing the film!**



Baader AstroSolar

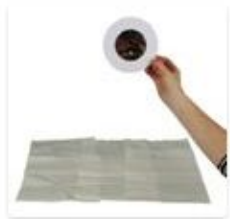

8. Now put a 50mm (2") wide stripe of strong cardboard around the objective lens or telescope dew cap and tape the ends with twin-sided adhesive tape. Repeat this procedure 3 times with twin-sided tape between each layer to produce a stiff 50mm long cardboard cylinder that precisely fits onto your optical instrument.
9. Finally, glue the AstroSolar® Safety-Film holder onto the 50mm cylinder while the cylinder is still mounted onto the front end of your telescope.



Your homemade solar filter for visual and photographic use is ready! Store it properly!

Baader AstroSolar

... Teleskope & Spektive



... Teleobjektive



... Feldstecher



Baader AstroSolar



Thousand Oaks SolarLite

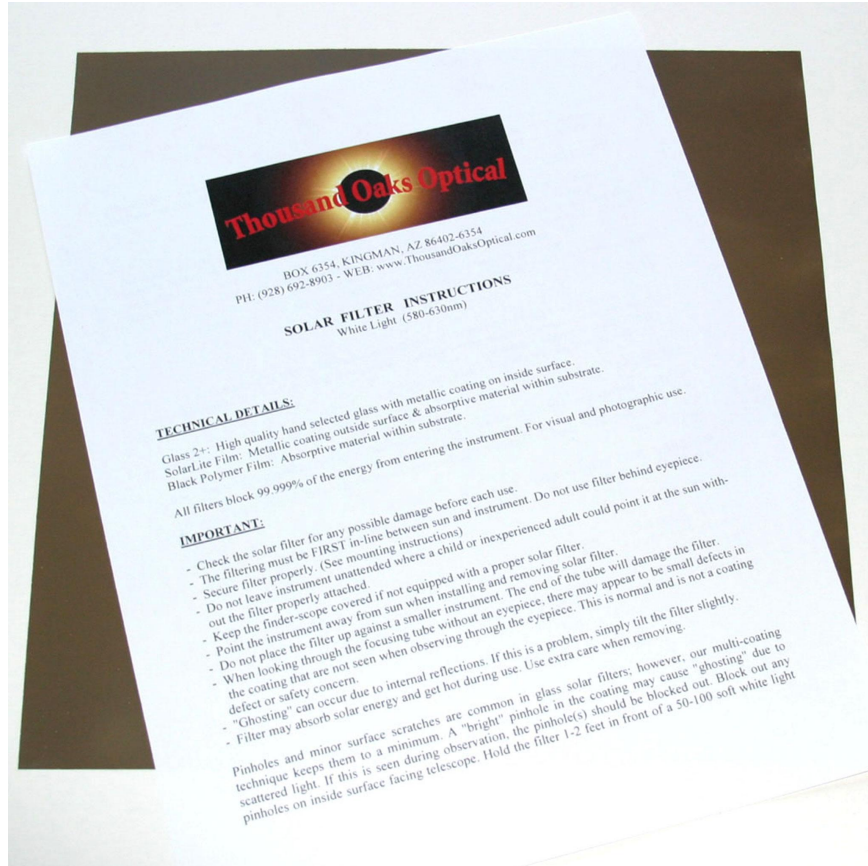

Thousand Oaks SolarLite



Thousand Oaks SolarLite

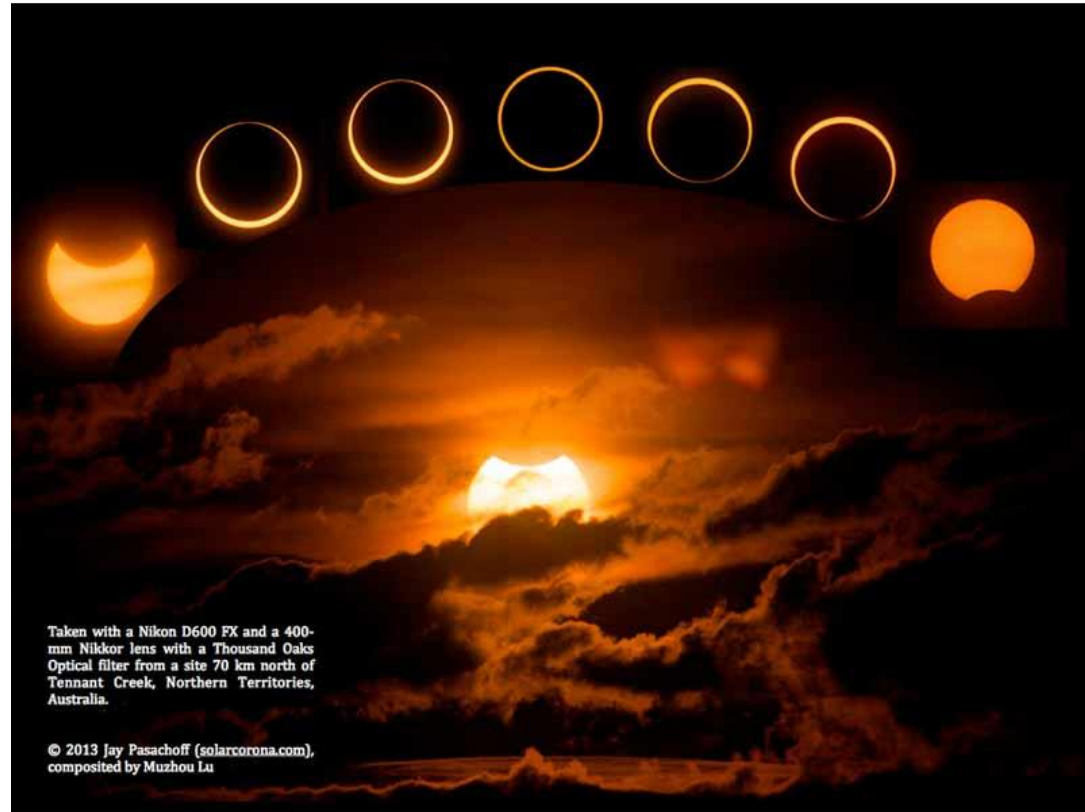

Taken with a Nikon D600 FX and a 400-
mm Nikkor lens with a Thousand Oaks
Optical filter from a site 70 km north of
Tennant Creek, Northern Territories,
Australia.

© 2013 Jay Pasachoff (solarcorona.com),
composed by Muzhou Lu

Filtre en verre



Filtre en verre



Filtres - Sécurité

Parfaitement sécuritaire
pour les yeux et le
télescope

Vérifier l'état du filtre

Vérifier qu'il est bien en
place.



Prisme d'Herschel

Solar eyepieces

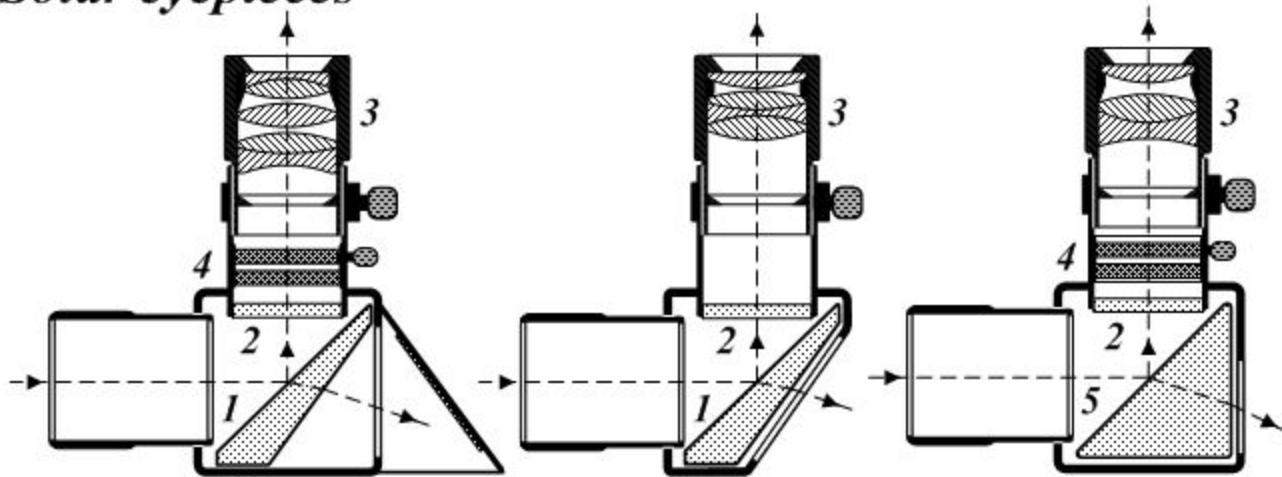

*1 - Herschel wedge 2 - Neutral density filter 3 - Eyepiece
4 - Variable transmission polarizing filter 5 - Right angle prism*

Prisme d'Herschel



Prisme d'Herschel

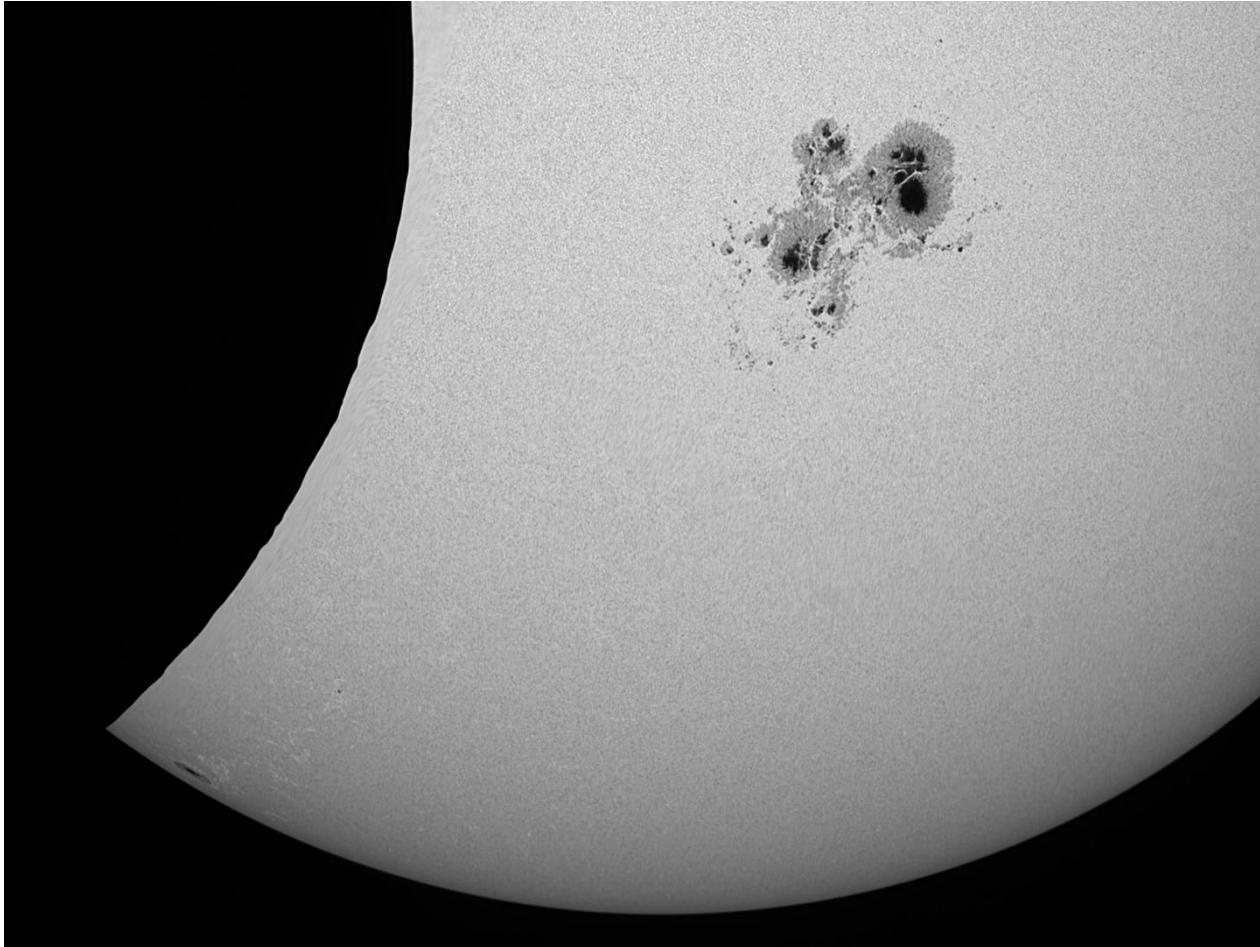

Filtre H-alpha

Lunt ST35

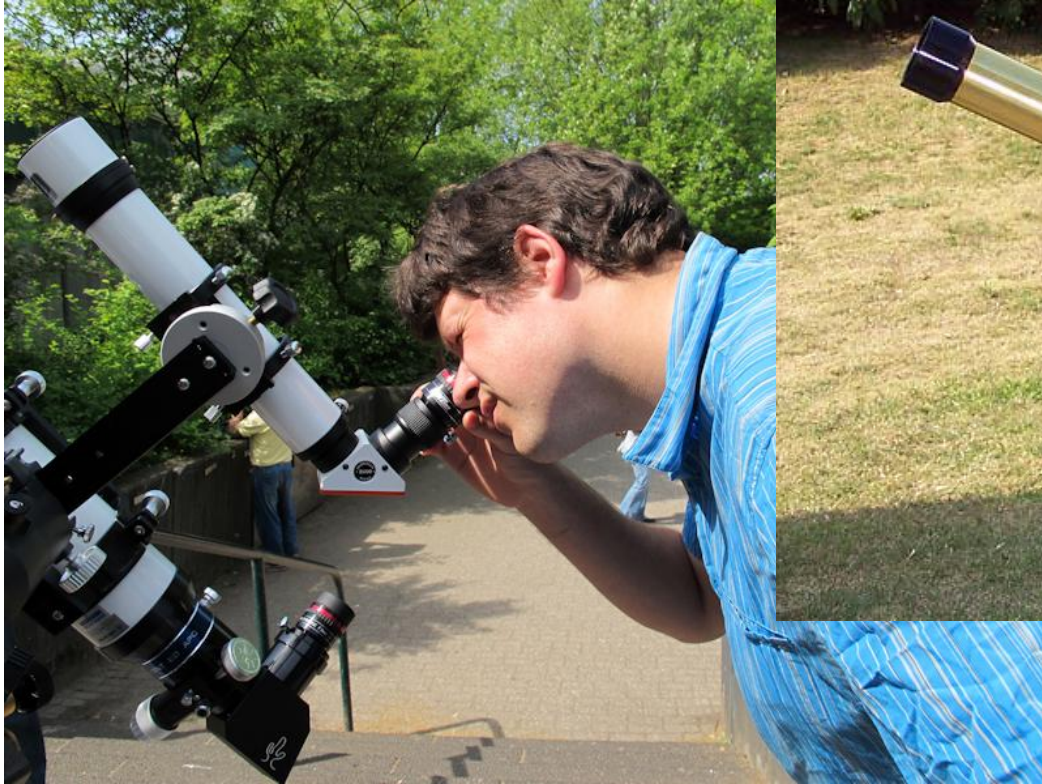

Coronado PST

Filtre H-alpha

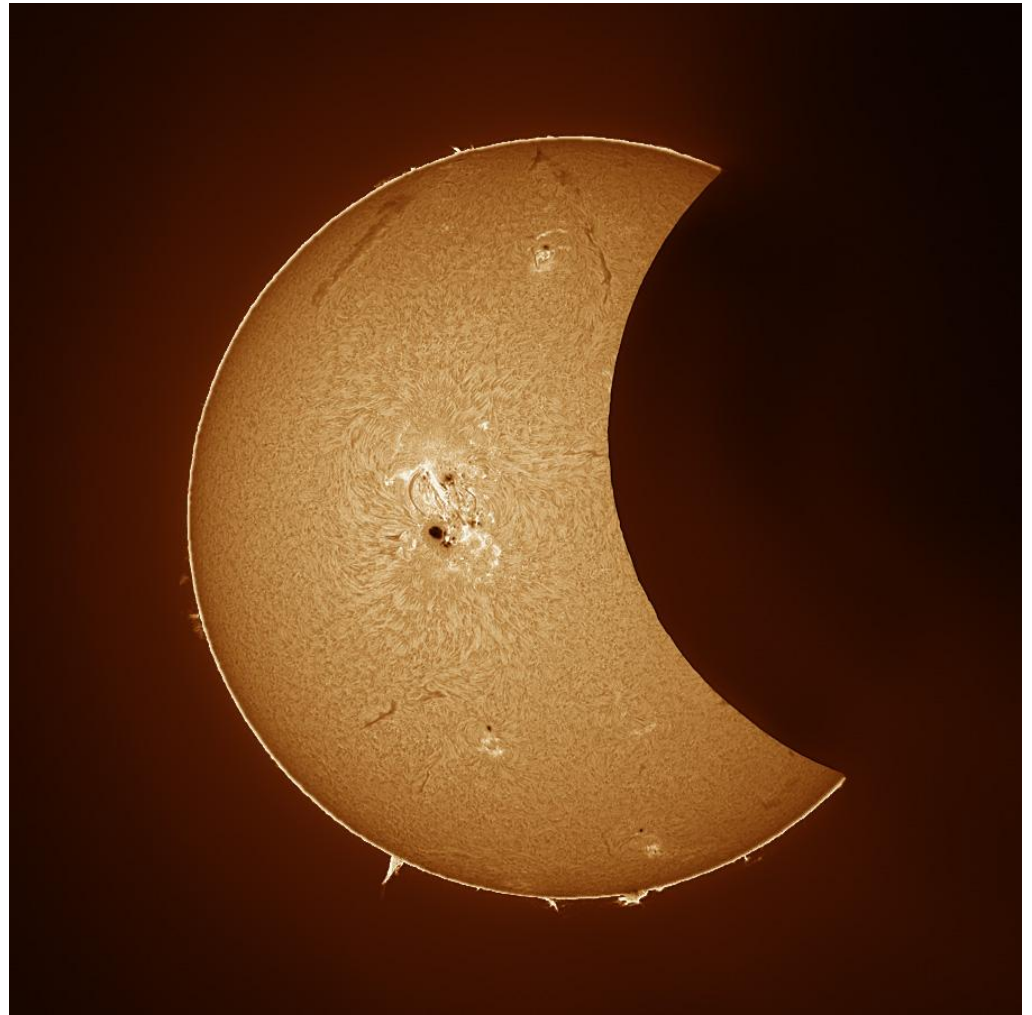

L'éclipse solaire aux États-Unis



Distances à partir de Montréal

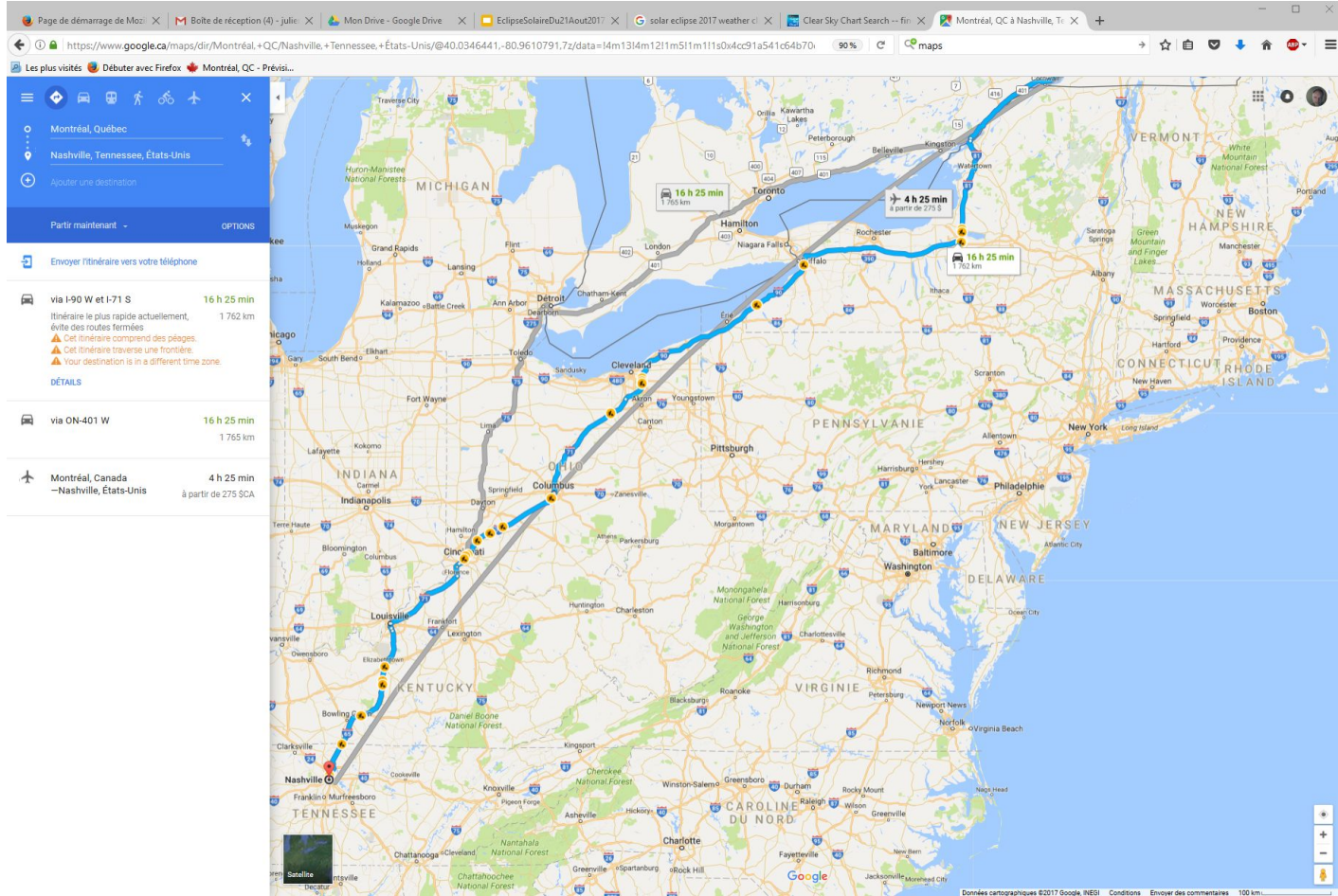

Distances à partir de Montréal



Prévisions climatiques

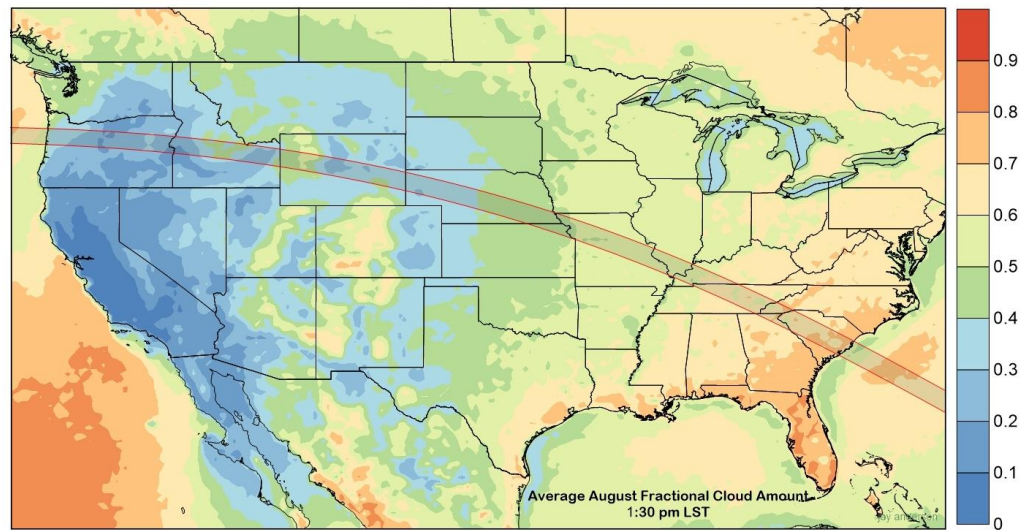
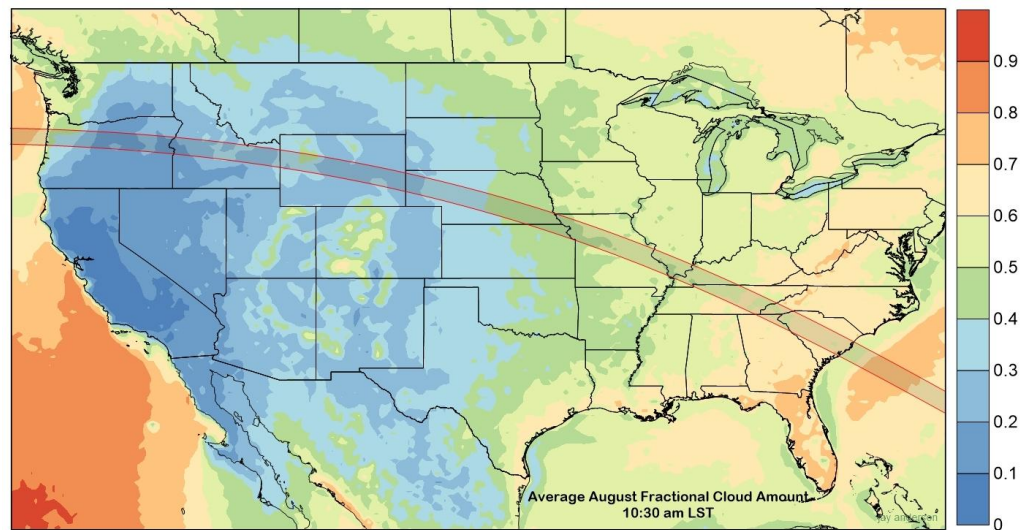

Prévisions climatiques

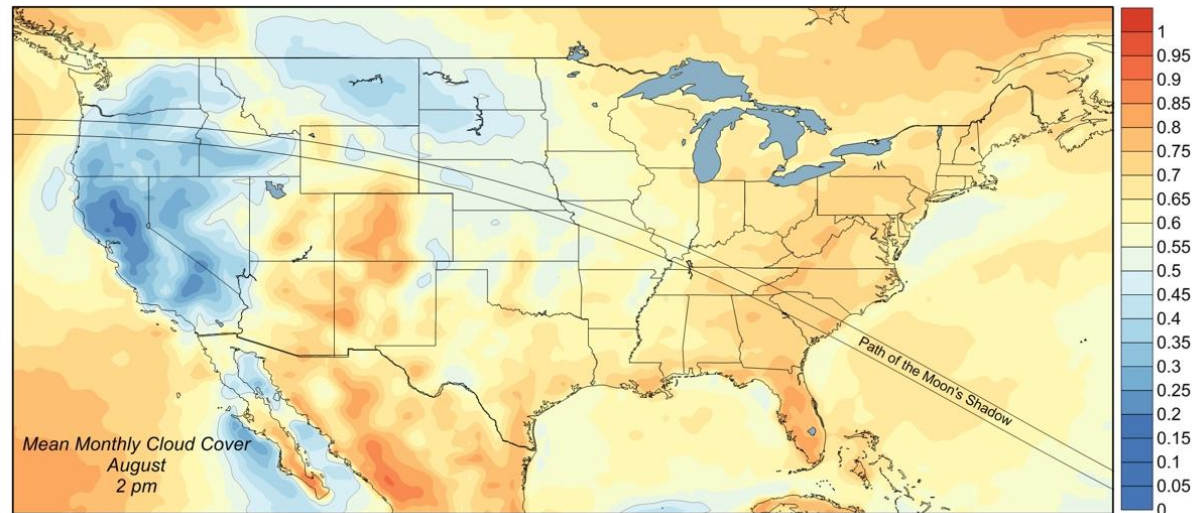
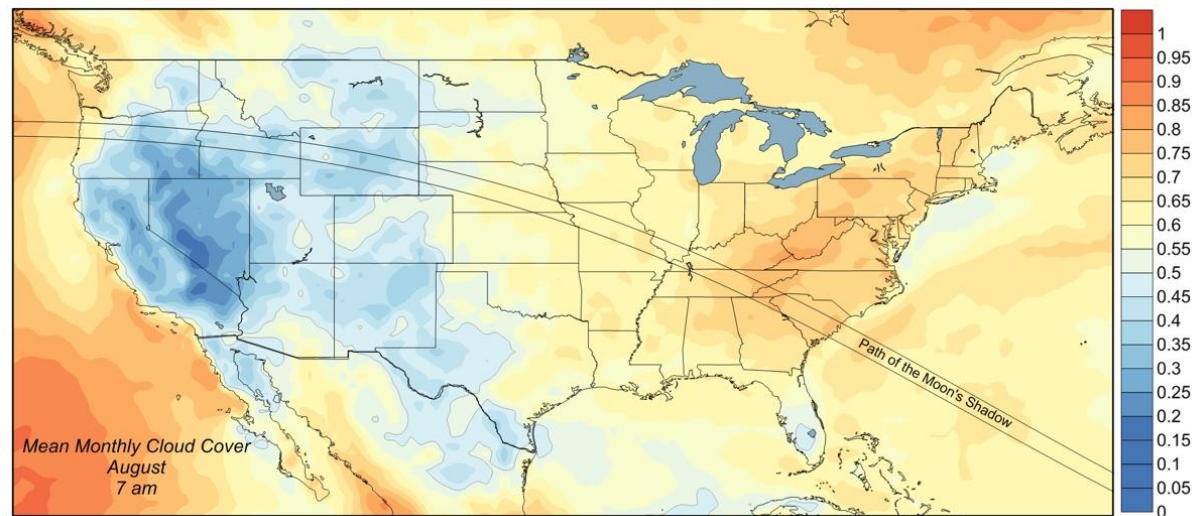

Prévisions climatiques

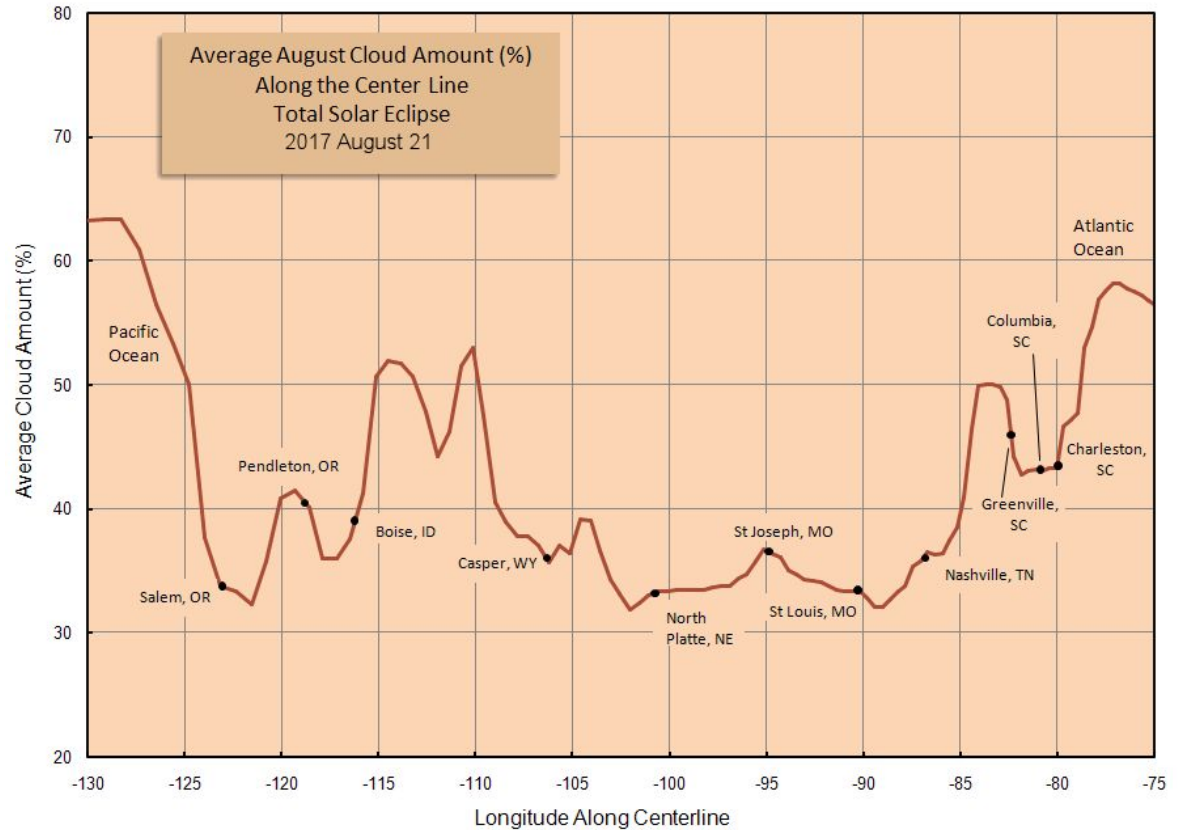

Prévisions climatiques

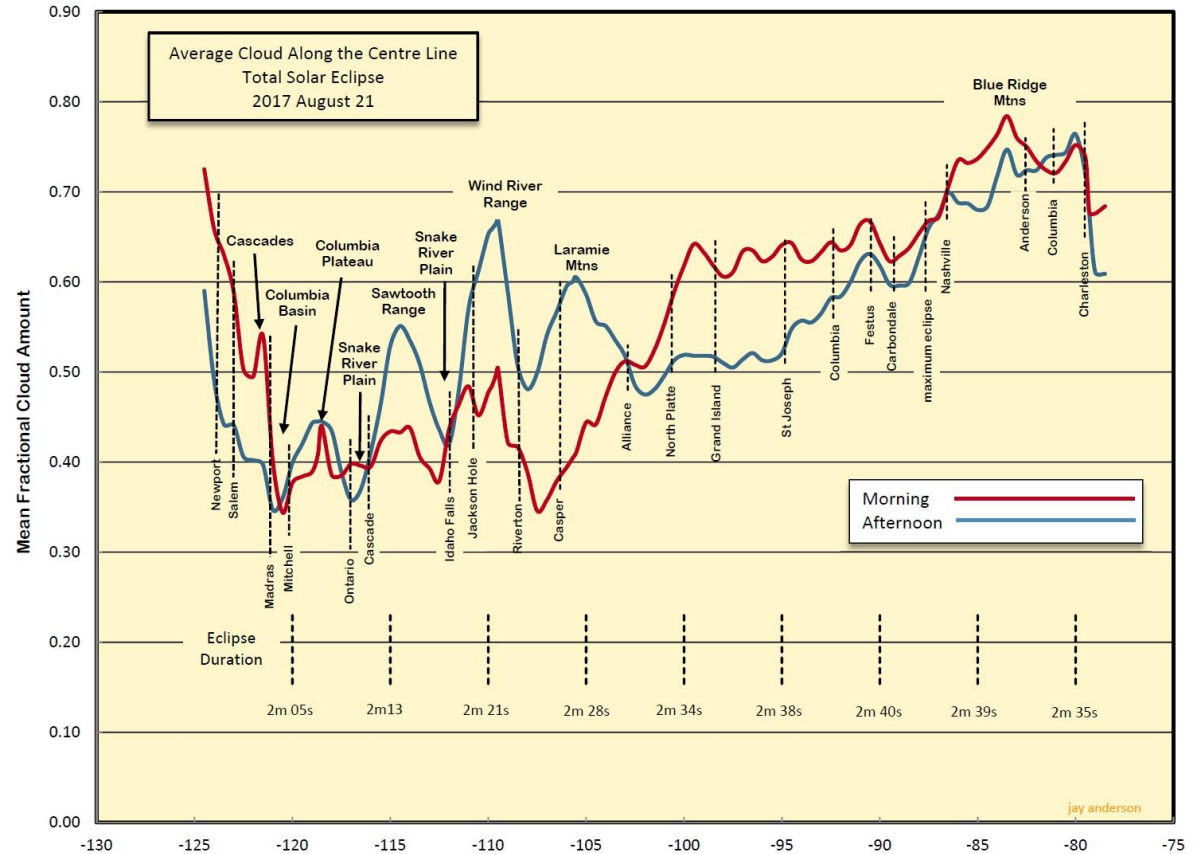

Prévisions météorologiques

www.cleardarksky.com

Prévisions
météorologiques
et astronomiques
précises sur deux
jours

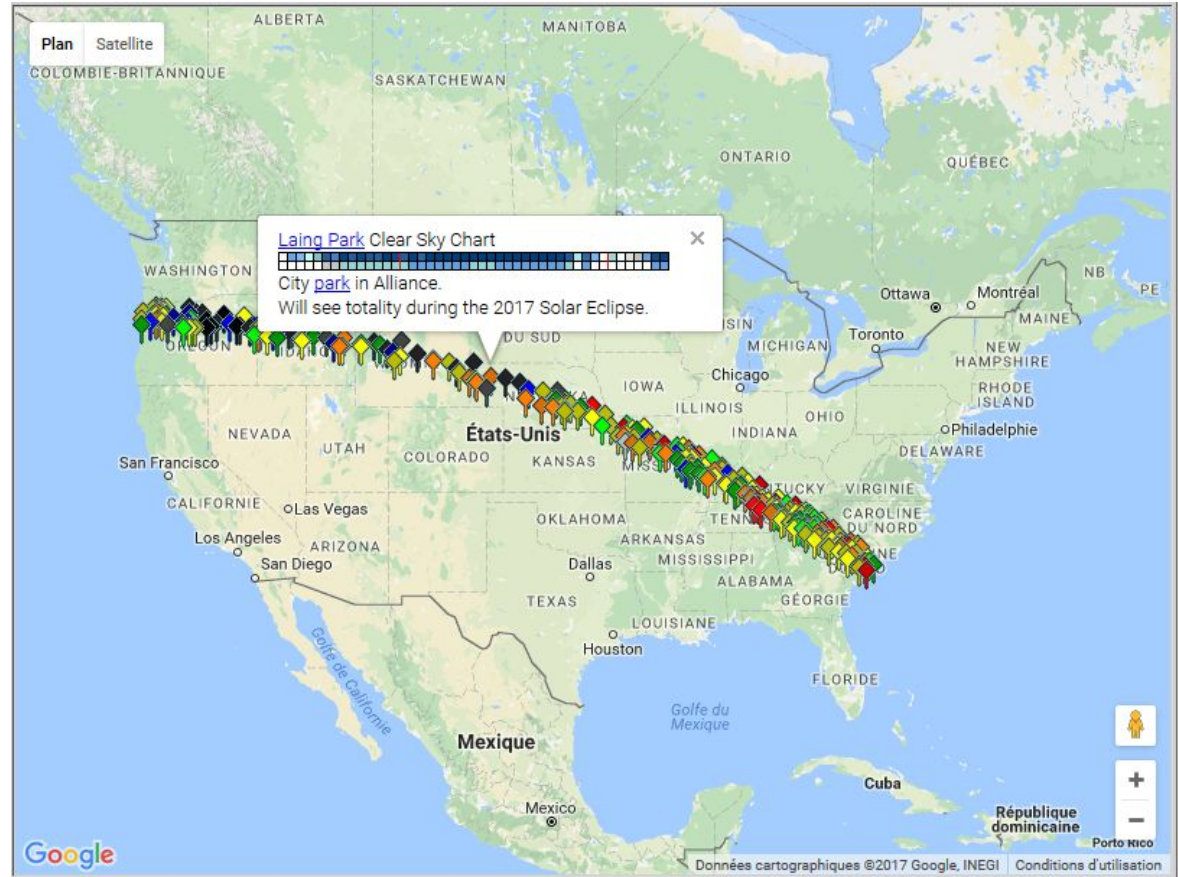

Mobilité

Il faut pouvoir se déplacer de 500km à l'est ou à l'ouest la journée avant pour aller sous des cieux plus cléments

Il y aura des bouchons monstres le lundi 21 août...

Réervations

Tout est réservé depuis l'année dernière...

Les prix sont montés en flèches...

Observations à faire lors d'une éclipse totale

1. Premier contact
2. Image solaire en croissant par un trou
3. Croissant fin de soleil
4. Vénus
5. Grains (ou perles) de Baily
6. Le diamant
7. Deuxième contact
8. Protubérances et chromosphère (limbe est)
9. Couronne solaire
10. Ciel étoilé
11. Crépuscule circulaire
12. Protubérances et chromosphère (limbe ouest)
13. Troisième contact
14. Le diamant
15. Grains de Baily
16. Vénus
17. Croissant fin de soleil
18. Dernier (quatrième) contact

Premier contact

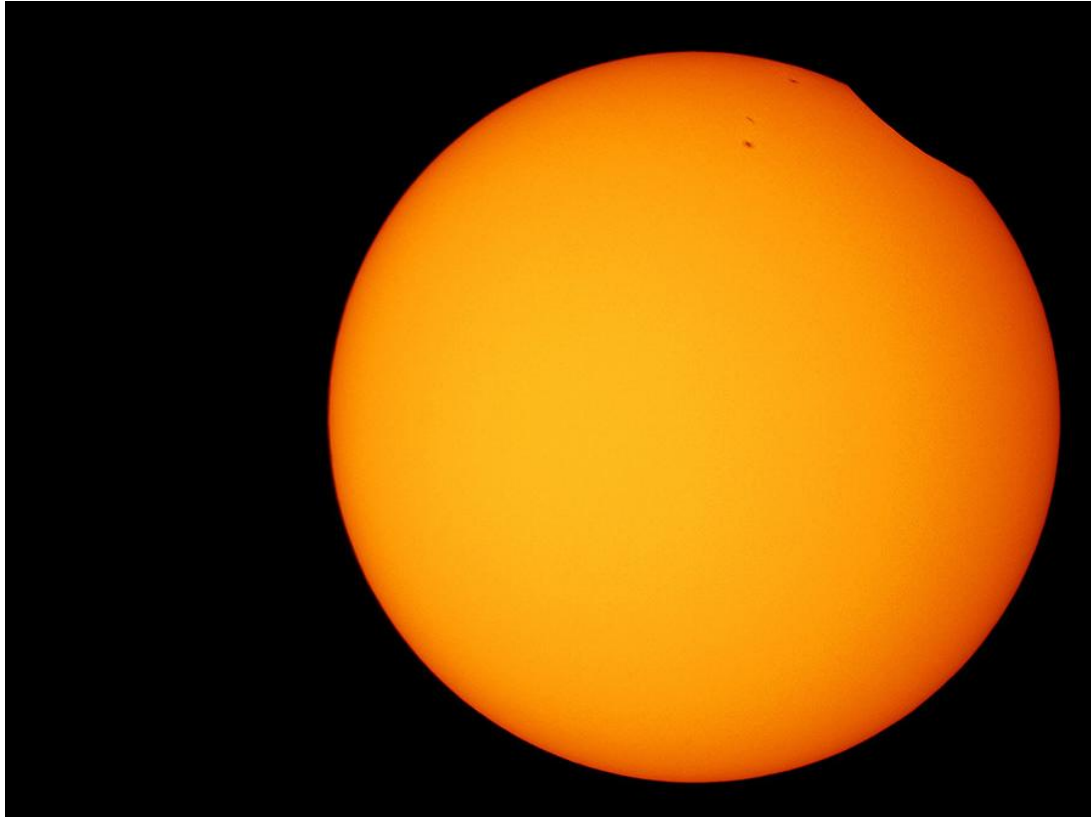

Il faut être fin prêt pour une aventure de 2 heures et demi

Image solaire en croissant par un trou



Image solaire en croissant par un trou



Croissant du Soleil



Transits multiples devant le Soleil



Transits multiples devant le Soleil



Transits multiples devant le Soleil



Vénus

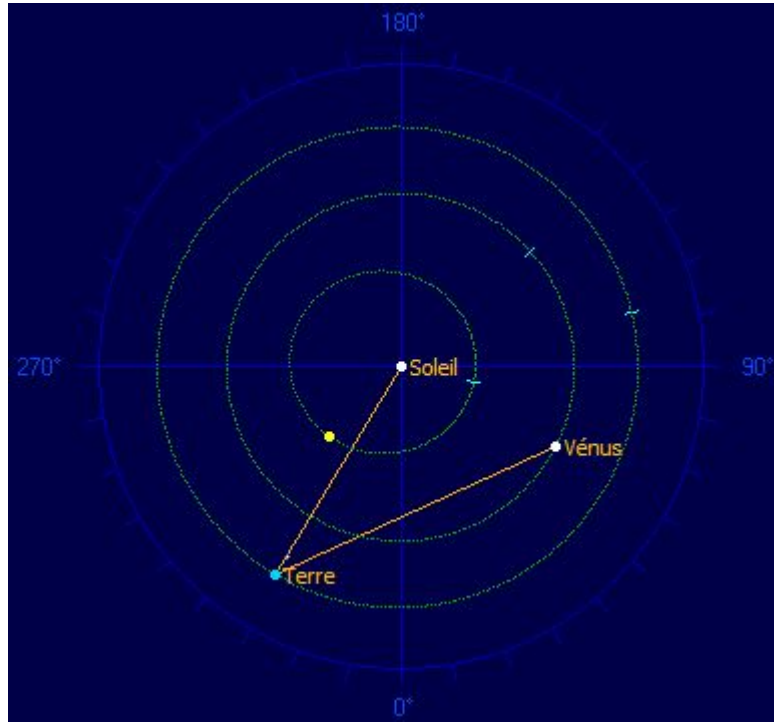

Vénus: 34.1 degrés ouest

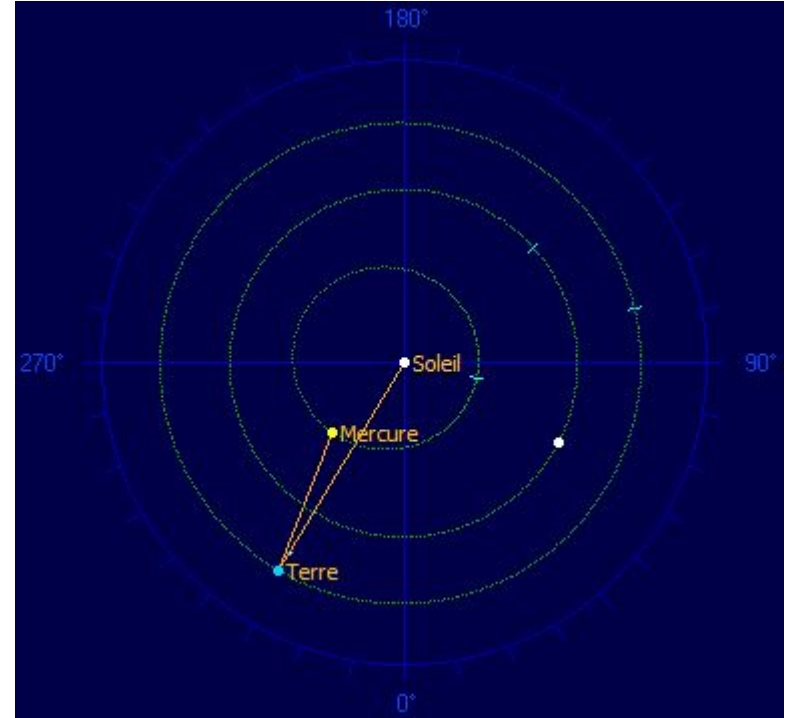

Mercure: 9.3 degrés est

Vénus

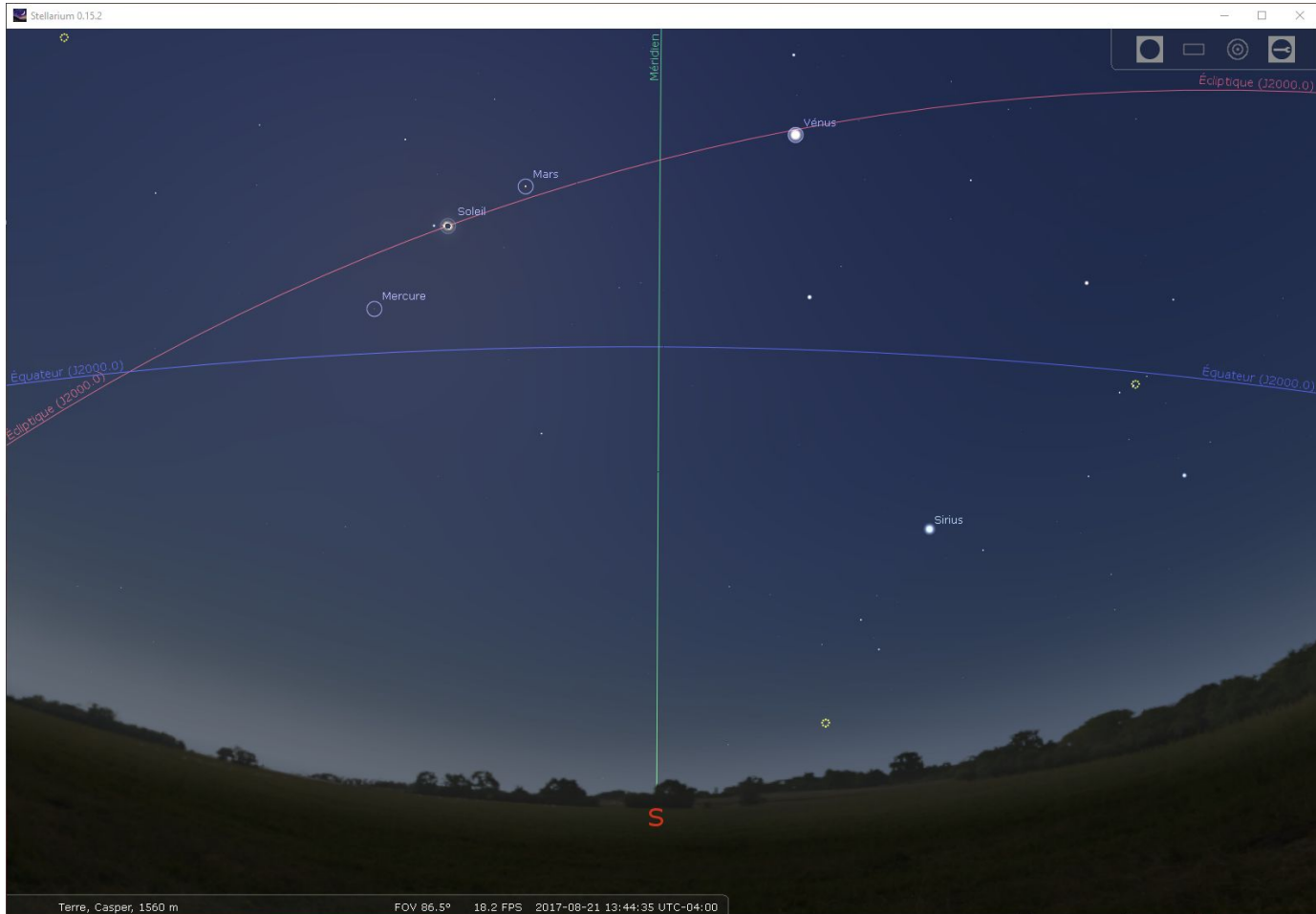

Vénus



Total Solar Eclipse 1997

© 1997 Úpice observatory © 2010 Miloslav Druckmüller

Grains de Baily

En astronomie, les **grains de Baily** est un phénomène optique qui peut être observé durant une éclipse solaire totale. Le phénomène est causé par les irrégularités du relief lunaire. Peu de temps avant la totalité, la lumière du Soleil brille à travers les vallées entre les montagnes de la Lune. Pendant quelques secondes, des points lumineux apparaissent sur le limbe lunaire, comme des perles disposées sur un collier.



Le diamant

Le **diamant**, qui peut être observé juste avant la disparition du disque solaire, est un cas particulier de grain de Baily, lorsqu'il ne reste qu'un seul point lumineux.



Deuxième contact

Quand le diamant disparaît, la Lune recouvre complètement le Soleil et l'éclipse solaire totale proprement dite commence. Elle durera au maximum 2 minutes 40 secondes au Kentucky. Elle durera 2 minutes 35 au Nebraska.

On peut observer à l'oeil nu.

Protubérances

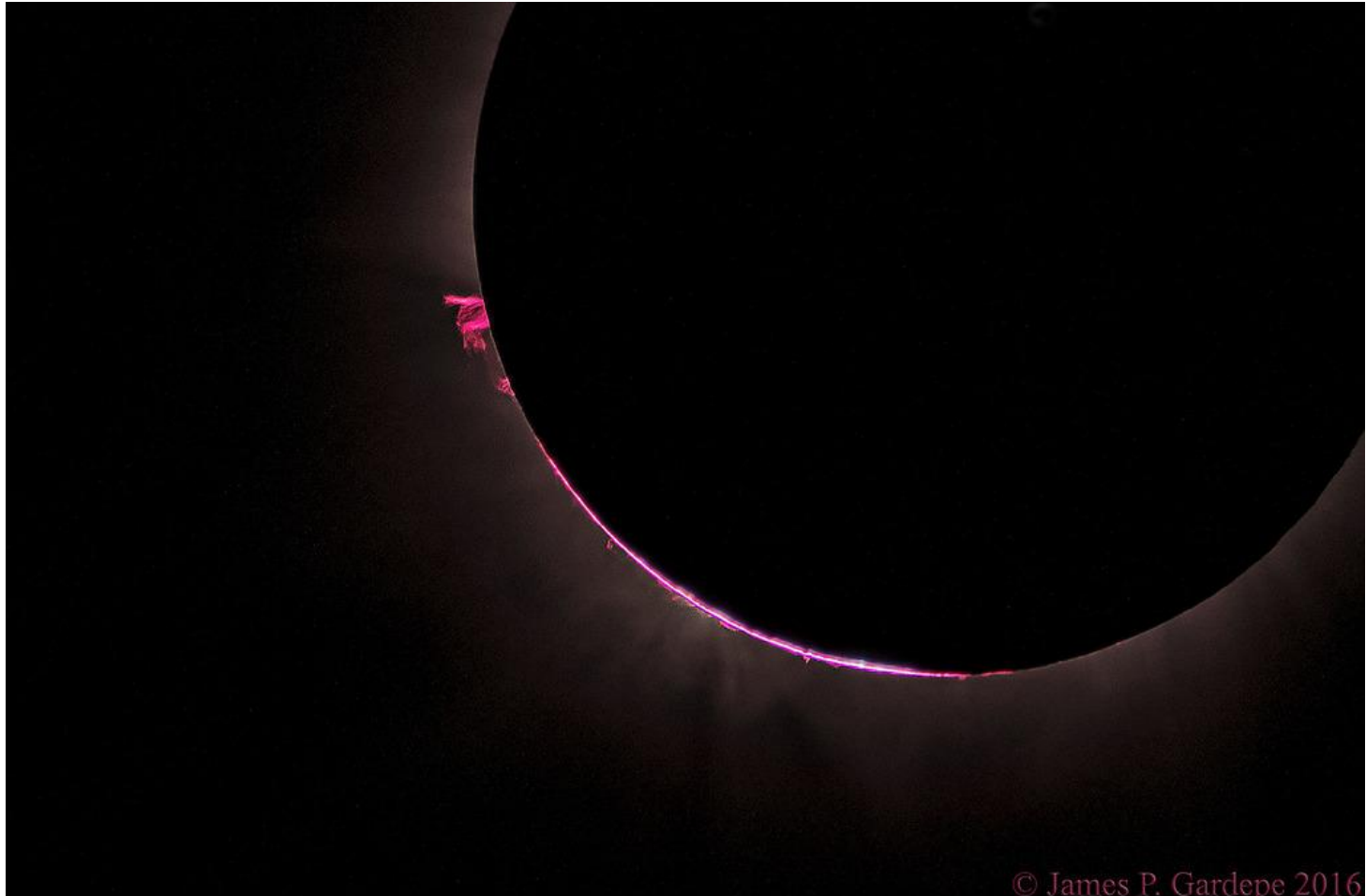

Chromosphère

La chromosphère est la basse atmosphère du Soleil, ou par extension, d'une étoile. C'est une fine couche rose de gaz, transparente pour la lumière visible, située entre la photosphère et la couronne solaire.

Elle n'est visible que lors d'une éclipse totale de Soleil ou à l'aide d'un coronographe.

Sa couleur rose est due à l'émission lumineuse de l'hydrogène ionisé à la longueur d'onde H α (656,3 nm).



Couronne solaire

La **couronne solaire** est la partie de l'atmosphère du Soleil située au-delà de la chromosphère et qui s'étend sur plusieurs millions de kilomètres en se diluant dans l'espace.

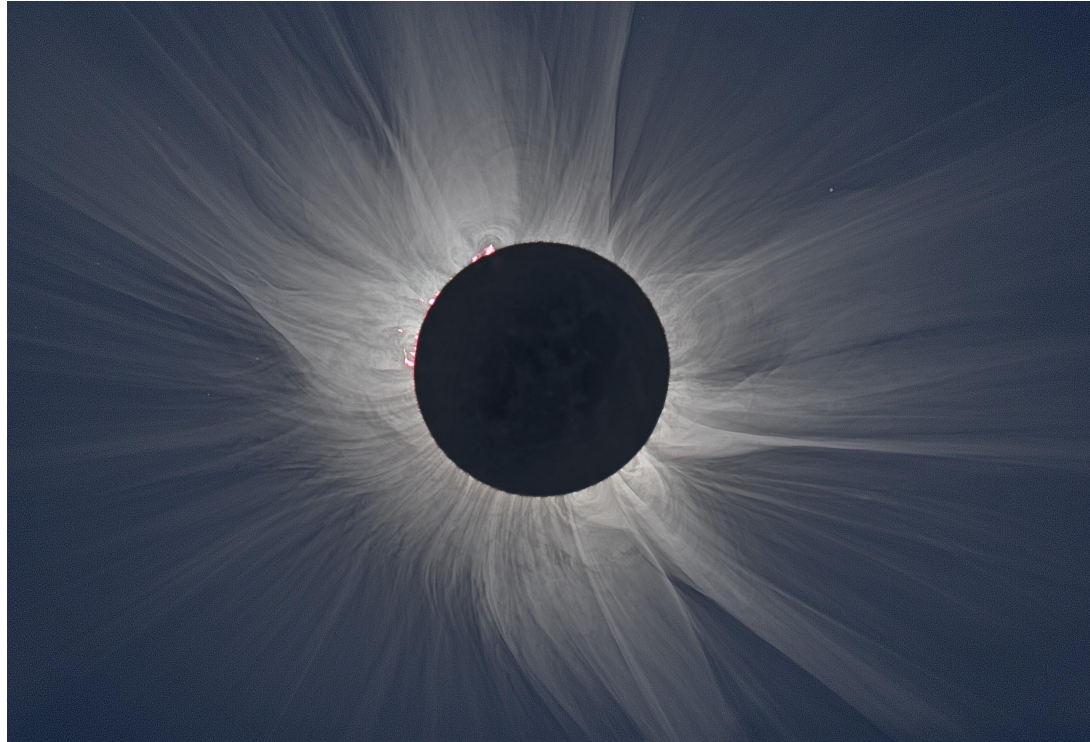

Ciel étoilé



Ciel étoilé

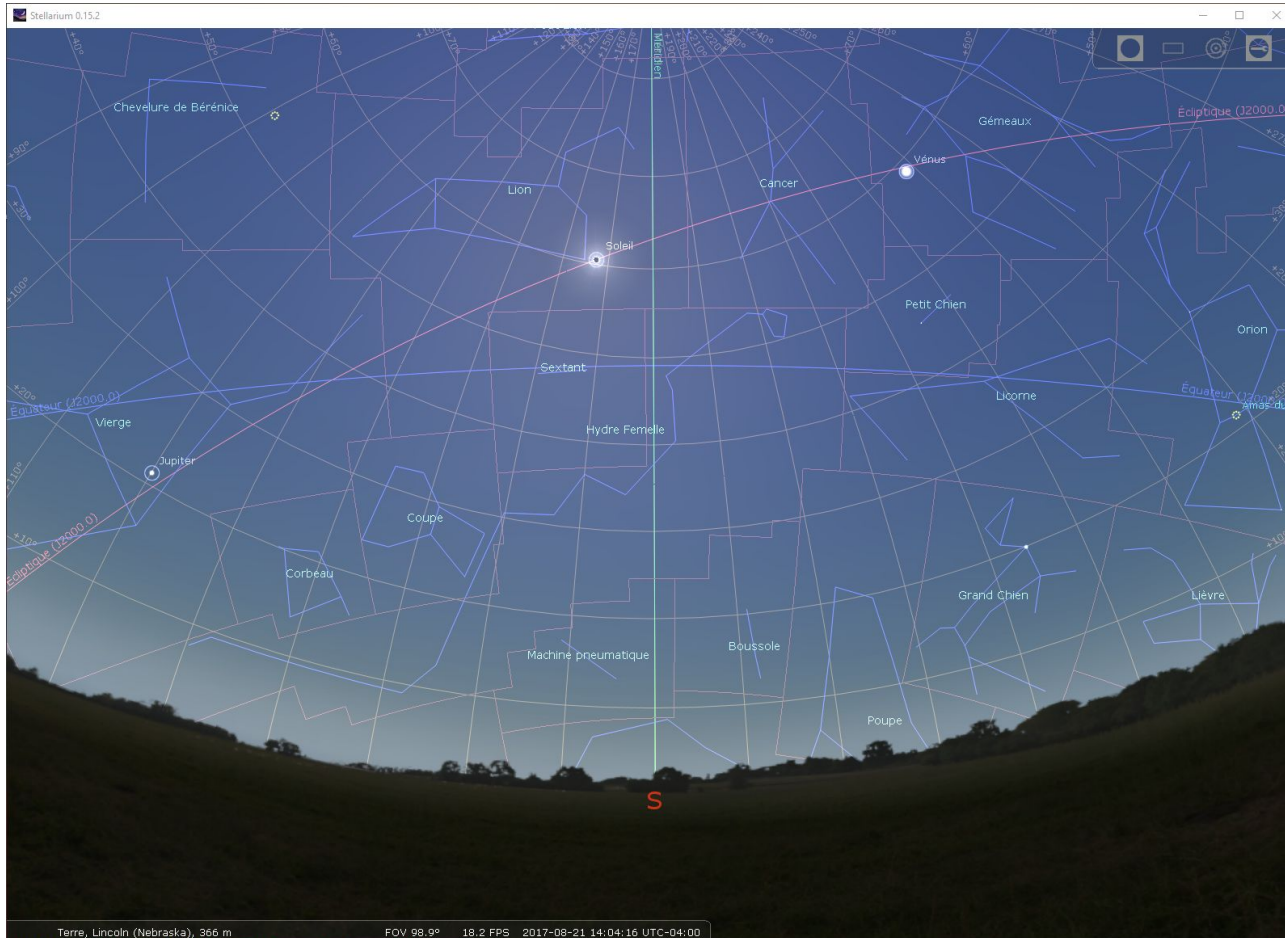

Ciel étoilé

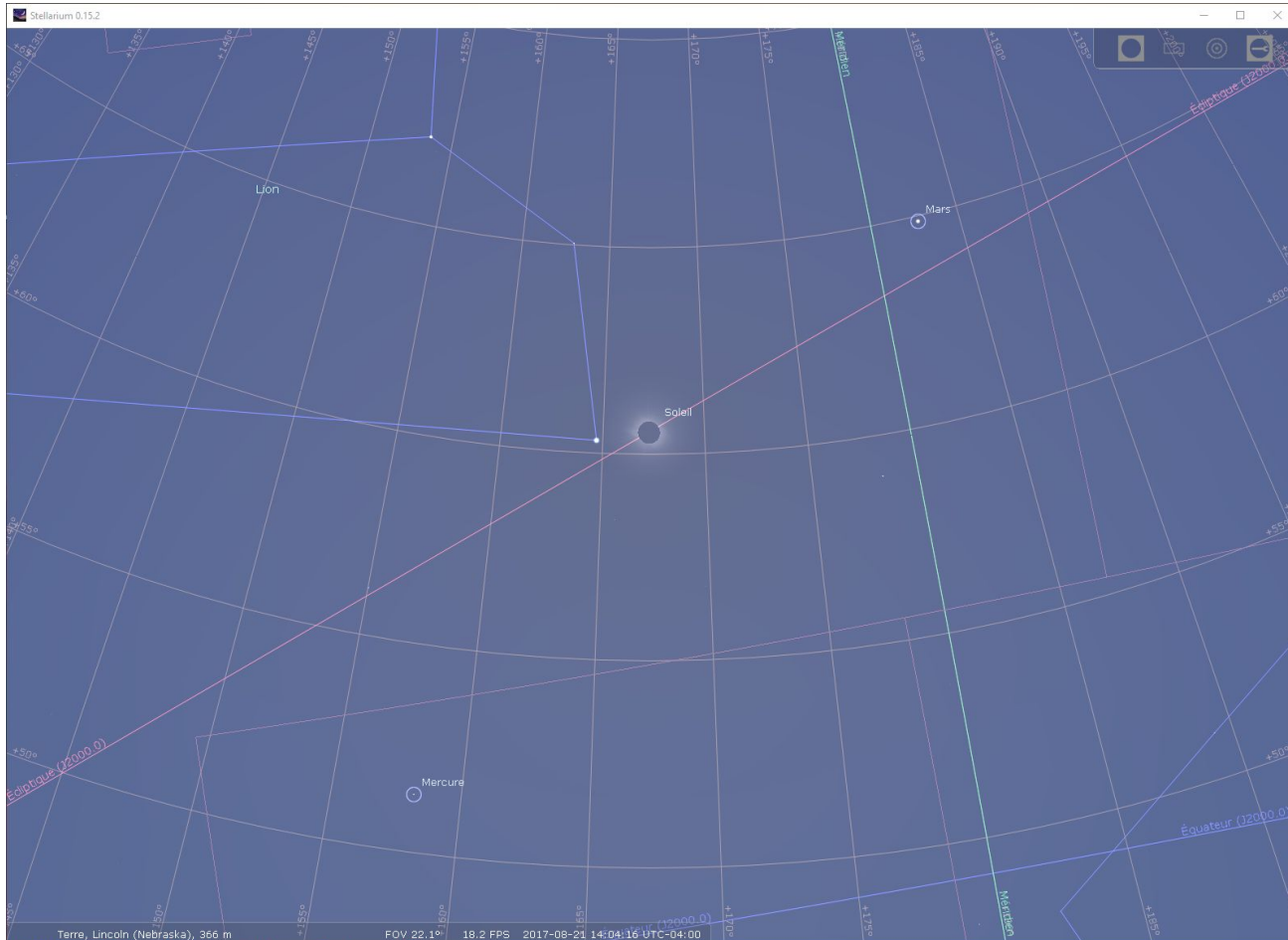

Crépuscule ordinaire



Crépuscule circulaire



Crépuscule circulaire

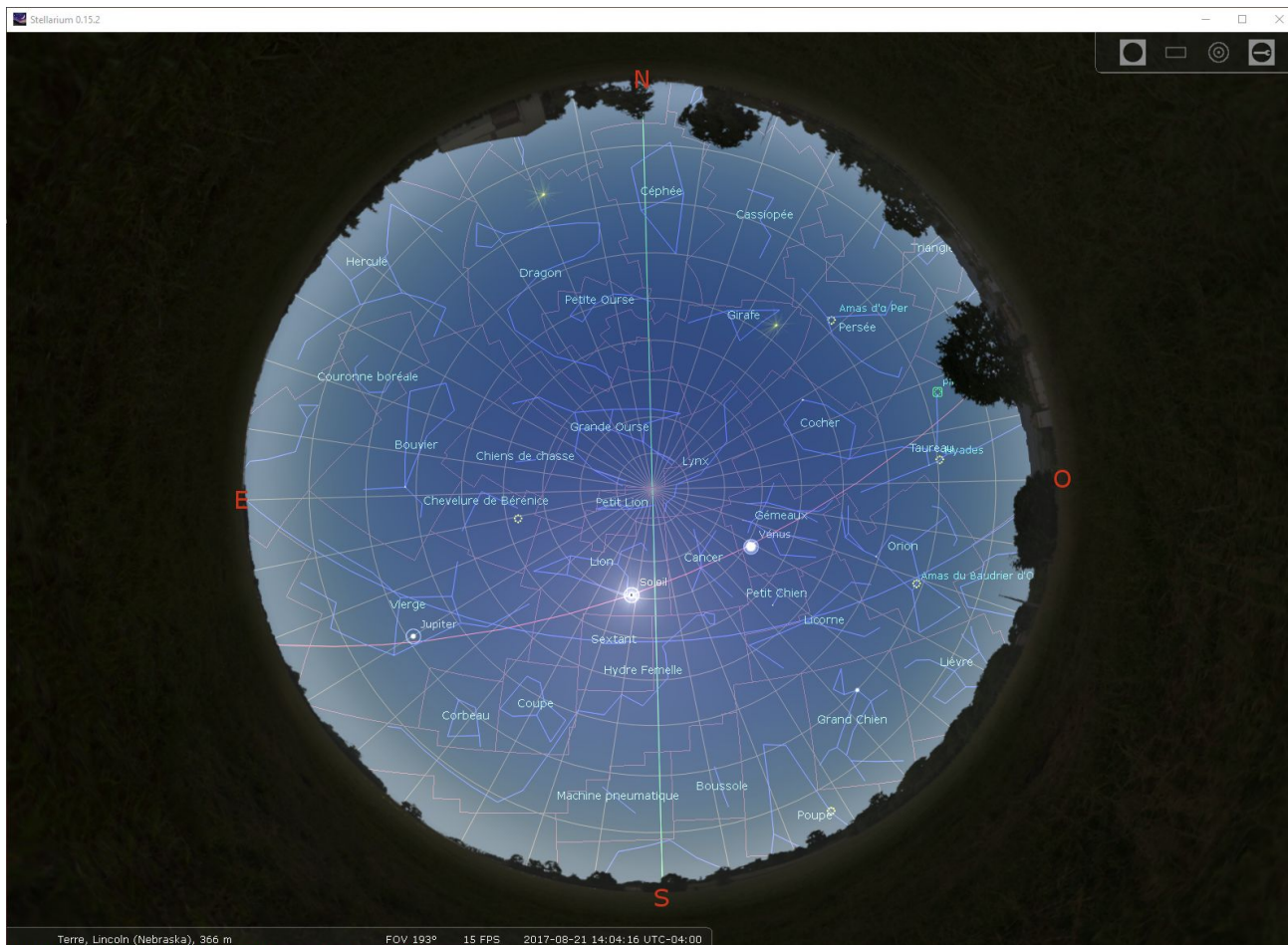

Crépuscule circulaire



Observations inverses

Entre le troisième et le quatrième contact, on revit la même séquence des observations, mais dans l'ordre inverse.

1. Protubérances et chromosphère (limbe ouest)
2. Troisième contact
3. Le diamant
4. Grains de Baily
5. Vénus
6. Croissant fin de soleil
7. Dernier (quatrième) contact

Phénomènes divers

- Diminution de la température, vent qui se lève.
- Oiseaux qui cessent de chanter, animaux anxieux
- Cris, joies, rires, applaudissements, extase, larmes.
- Une expérience mémorable: certains veulent revivre cette expérience et deviennent des chasseurs d'éclipse.

La maison de l'astronomie

8074, rue
St-Hubert,
Montréal,
QC,
H2R 2P3

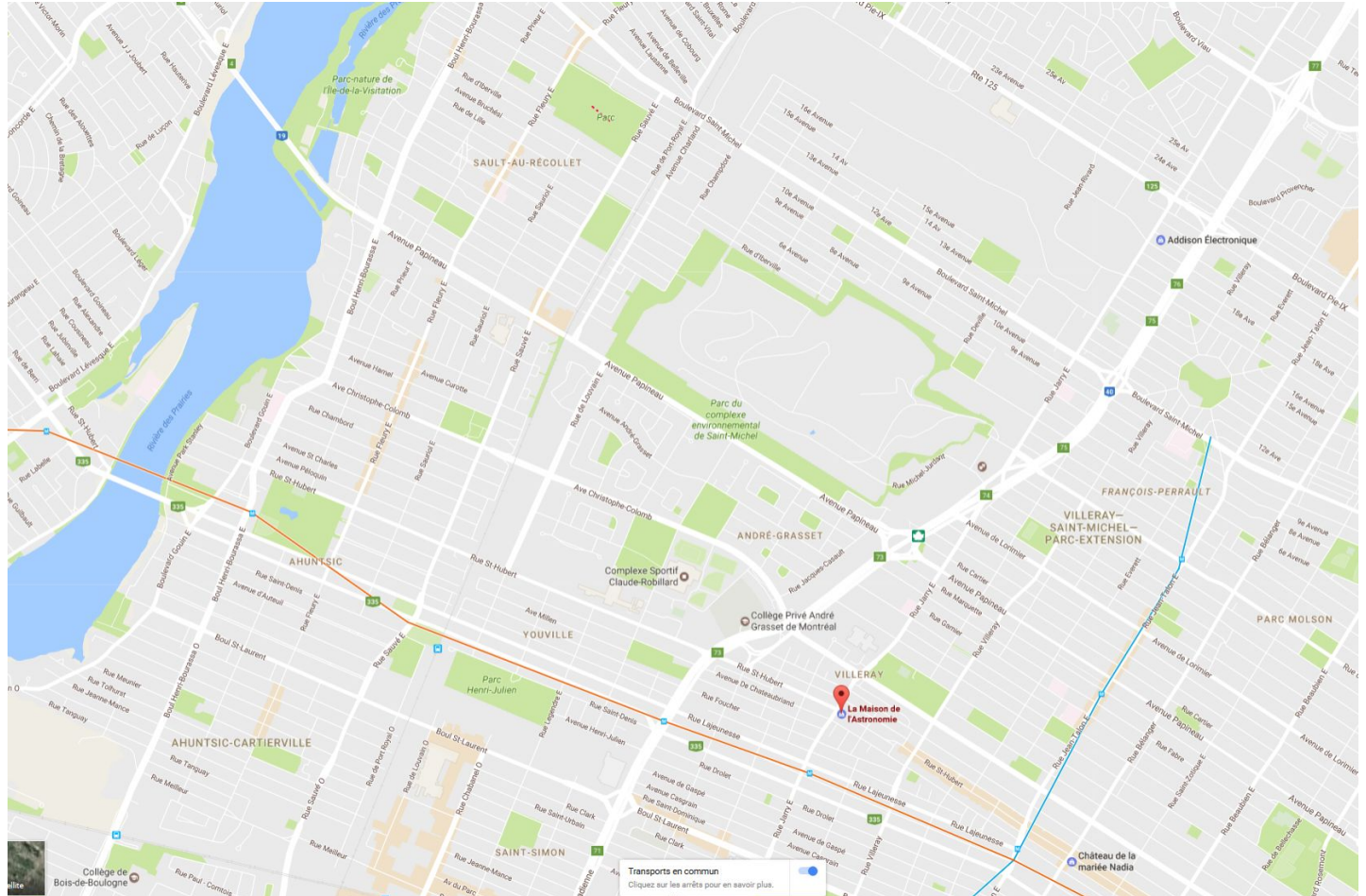

La maison de l'astronomie

8074, rue
St-Hubert,
Montréal, QC,
H2R 2P3

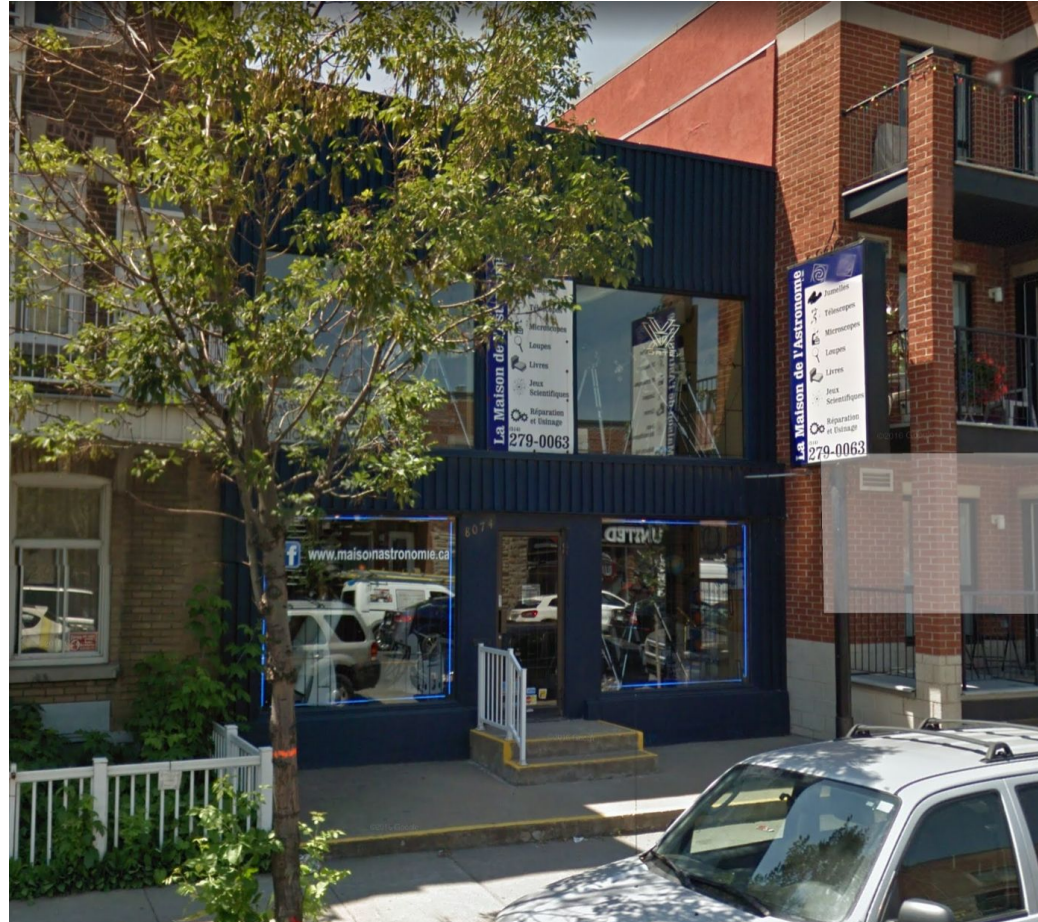

Société d'astronomie de Montréal (SAM)

La Société d'Astronomie de Montréal
7501, François-Perrault
Montréal, Québec
H2A 1M1, Canada

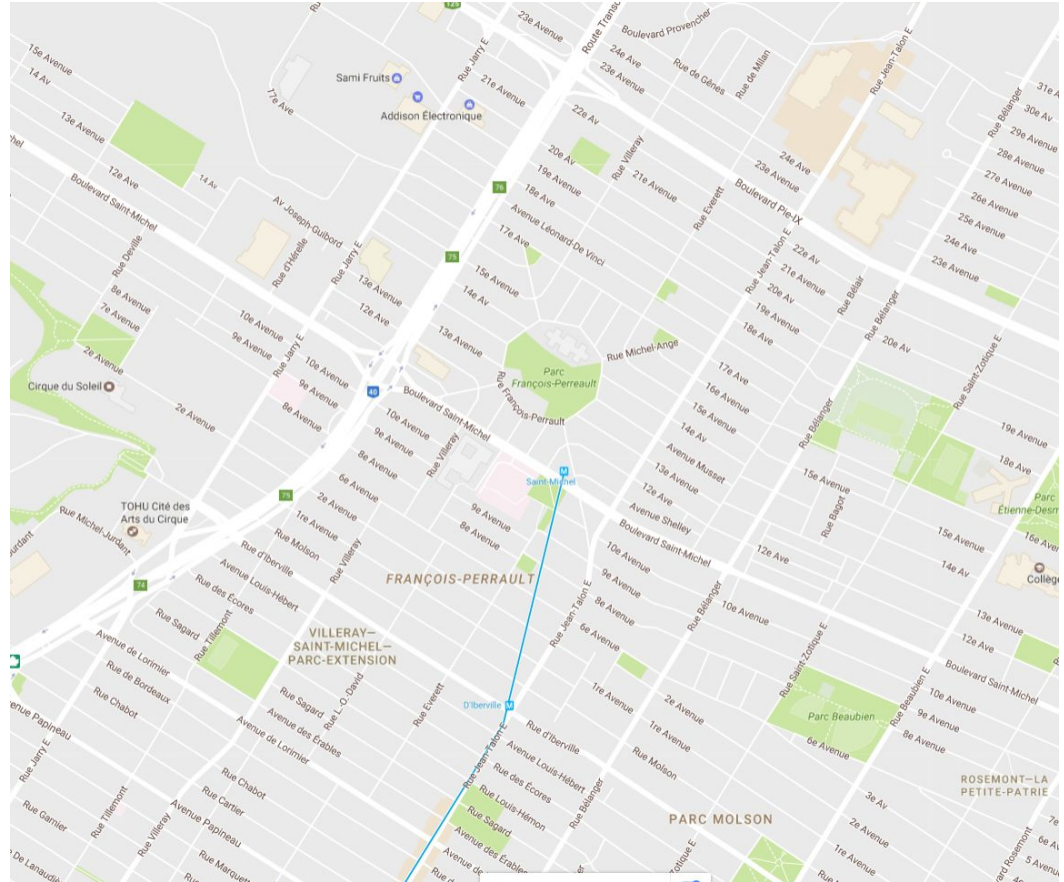

Société d'astronomie de Montréal (SAM)

<http://www.lasam.ca>

Coût d'adhésion annuel

40\$ pour un membre adulte / 50\$ pour un plan famille

22\$ pour un étudiant

Société d'astronomie de Montréal (SAM)

- Réunions et conférences tous les mardis soirs
- Soirées publiques d'observations au parc-nature de l'Île-de-la-Visitation
- Soirées d'astronomie au terrain d'observation de St-Valérien.
- Liste de diffusion électronique
- Membres de la Fédération des astronomes amateurs du Québec
- Membres de la Société royale d'astronomie du Canada

Une présentation de la
Société d'astronomie de Montréal.
Un organisme bénévole à but non lucratif.

<http://www.lasam.ca/>

Merci de votre attention



La Société d'astronomie de Montréal
Centre francophone de Montréal
de la Société royale d'astronomie du Canada

